

Distanziali e minuterie

Distanziali plastici filettati 3MA femmina-femmina

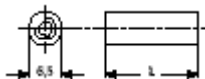

CORPO: derlin
TEMPERATURA DI LAVORO: 110° max

lunghezza	Art.	lunghezza	Art.
4	GT/NS04M3	15	G5185
10	G-D3020	20	G-D3022

Vite	A	B
M-6	6.8mm	12.7mm

lunghezza	Art.	lunghezza	Art.
6,4	G-SS14264	12,7	G-SS144127

* minimo ordinabile 1000 pezzi escluso stock

Vite	A	B
M-9	10.1mm	12.7mm

lunghezza	Art.	lunghezza	Art.
9,5	G-SS38395		

* minimo ordinabile 1000 pezzi escluso stock

Distanziali plastici femmina-femmina

Distanziali plastici femmina-femmina

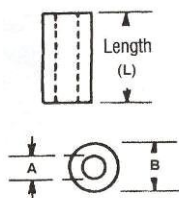

CORPO: CPVC
COLORE: grigio

Vite	A	B
M-2.6	3.1mm	6.4mm

lunghezza	Art.	lunghezza	Art.
6,4	G-SS4264	15,9	G-SS45159
9,5	G-SS4395	25,4	G-SS48254
12,7	G-SS44127	38,1	G-SS412381

* minimo ordinabile 1000 pezzi escluso stock

Vite	A	B
M-3	3.7mm	6.4mm

lunghezza	Art.	lunghezza	Art.
6,4	G-SS6264	19,1	G-SS66191
9,5	G-SS6395	25,4	G-SS68254
12,7	G-SS64127	38,1	G-SS610318
15,9	G-SS65159		

* minimo ordinabile 1000 pezzi escluso stock

Vite	A	B
M-4	4.5mm	6.4mm

lunghezza	Art.	lunghezza	Art.
6,4	G-SS8264	12,5	G-SS84127
9,5	G-SS8395	15,9	G-SS85159

* minimo ordinabile 1000 pezzi escluso stock

Vite	A	B
M-4	4.5mm	9.5mm

lunghezza	Art.	lunghezza	Art.
9,5	G-SS83L95	38,1	G-SS812L381

* minimo ordinabile 1000 pezzi escluso stock

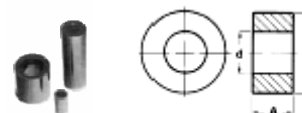

CORPO: nylon

Art.	A	D	d	Art.	A	D	d
G-5515305	3	4.5	2.4	G-50701026	10	10	5.5
G-5516505	5	5	2.7	G-50701226	12	10	5.5
G-5521306	3	7	3.3	G-50701526	15	10	5.5
G-5021405	4	7	3.3	G-50702026	20	10	5.5
G5021/35/5	5	7	3.3	G-50702526	25	10	5.5
G5021/35/7/05	7	7	3.7	G-50156426	4	10	6
G-5229526	5	6	4	G-55501026	10	10	6.1
G5192	10	6	4	G-5302426	4	12	6.4
G5193	15	6	4	G-55520516	5	13	8.1
G5197	19	6	4	G-55521526	15	13	8.1
G5196	25	6	4	G-53008406	4	17	8.4
G-50154426	4	10	4.3	G-51461526	15	15	10.5
G-55481026	10	8	5.1				

* minimo ordinabile 1000 pezzi escluso stock

Supporti reggischeda

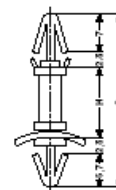

CORPO: nylon 6/6 UL94V-2
TEMPERATURA DI LAVORO: 120° max
Per schede spessore 1.6-2mm

Art.	A	Art.	A
G-CS0305	4,8	G-CS1016	15,9
G5200	6,4	G-CS1219	19,1
G-5205	9,6	G-CS1422	22,2
G-D3026	10	G5211	25,4
G5210	12,7	G5212	35

* minimo ordinabile 1000 pezzi escluso stock

Distanziali e minuterie

Supporti reggischeda miniatura RICHCO

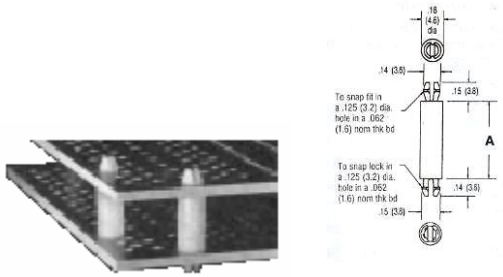

CORPO: nylon 6/6 UL94V-2

Art.	A	Art.	A
G-MSPM30148	4.8	G-MSPM801127	12.7
G-MSPM40164	6.4	G-MSPM1201191	19.1
G-MSPM60195	9.5	G-MSPM1401222	22.2
G-MSPM701111	11.1	G-MSPM1601254	25.4

* minimo ordinabile 1000 pezzi escluso stock

Supporti reggischeda RICHCO

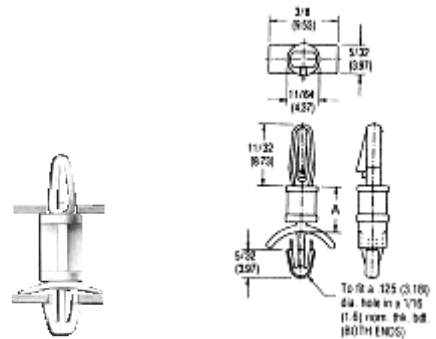

CORPO: nylon 6/6 UL94V-2

Art.	A	Art.	A
G-LCBSM201318	3.18	G-LCBSM601953	9.53
G-LCBSM301476	4.76	G-LCBSM7011111	11.11
G-LCBSM401635	6.35	G-LCBSM9011429	14.29
G-LCBSM501794	7.94		

* minimo ordinabile 1000 pezzi escluso stock

Supporti reggischeda miniatura RICHCO

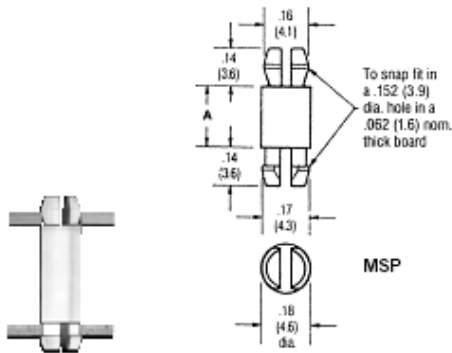

CORPO: nylon 6/6 UL94V-2

Art.	A	Art.	A
G-MSP40164	6.4	G-MSP1001159	15.9
G-MSP60195	9.5	G-MSP1201191	19.1
G-MSP801127	12.7	G-MSP1801286	28.6

* minimo ordinabile 1000 pezzi escluso stock

Supporti reggischeda RICHCO

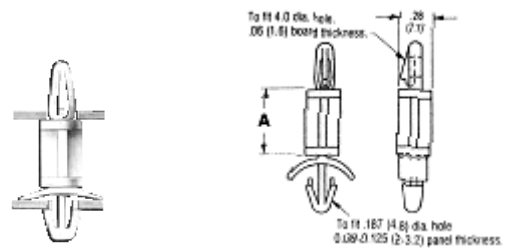

CORPO: nylon 6/6 UL94V-2

Art.	A	Art.	A
G-LCBS230148	4.8	G-LCBS21001159	15.9
G-LCBS240164	6.4		

* minimo ordinabile 1000 pezzi escluso stock

Supporti reggischeda miniatura RICHCO

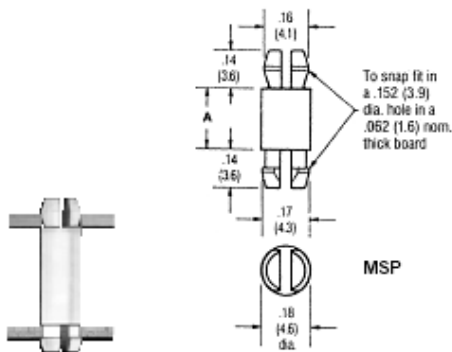

CORPO: nylon 6/6 UL94V-2

Art.	A	Art.	A
G-MSPE30148	4.8	G-MSPE1401222	22.2
G-MSPE1201191	19.1		

* minimo ordinabile 1000 pezzi escluso stock

Supporti reggischeda RICHCO

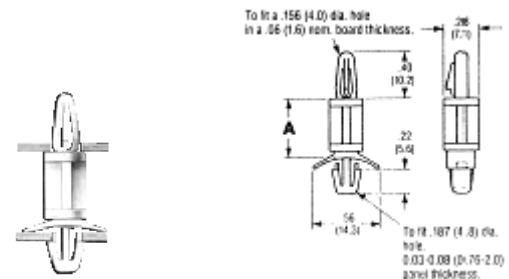

CORPO: nylon 6/6 UL94V-2

Art.	A	Art.	A
G-LCBS30148	4.8	G-LCBS801127	12.7
G-LCBS40164	6.4	G5213	15.9
G-LCBS60195	9.5	G-LCBS1201191	19.1
G-LCBS701111	11.1		

* minimo ordinabile 1000 pezzi escluso stock

Distanziali e minuterie

Supporti reggischeda adesivi

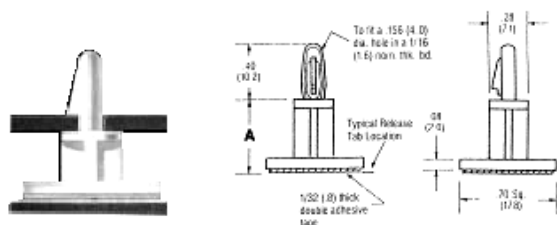

CORPO: nylon 6/6 UL94V-2

Art.	A	Art.	A
G5156	3	G-D3002	12
GDIST/LCBS03	4.8	G-LCBS801A127	12,7
G5150	6	G-LCBS1001A159	15,9
GDIST/LCBS04	6,4	G-LCBS1201A191	19,1
G-D3001	8	G-LCBS1401A222	22,2
GDIST/LCBS06	9.5	G5158	23

* minimo ordinabile 1000 pezzi escluso stock

Supporti reggischeda RICHCO

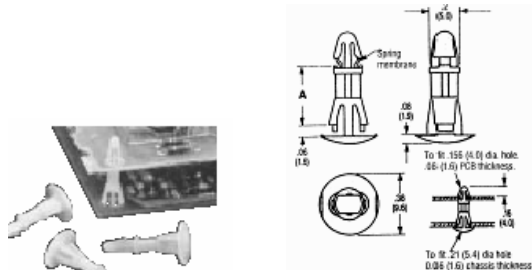

CORPO: nylon 6/6 UL94V-2

Art.	A	Art.	A
G-RLCBSRK60160	6	G-RLCBSRK1201120	12
G-RLCBSRK80180	8		

* minimo ordinabile 1000 pezzi escluso stock

Supporti reggischeda RICHCO

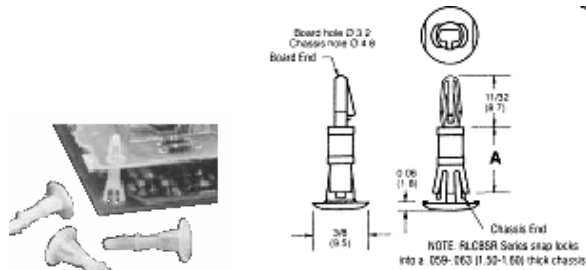

CORPO: nylon 6/6 UL94V-2

Art.	A	Art.	A
G-RLCBSR40164	6.4	G-RLCBSR801127	12,7
G-RLCBSR50179	7.9	G-RLCBSR1001159	15.9
G-RLCBSR60195	9.5		

* minimo ordinabile 1000 pezzi escluso stock

Supporti reggischeda



CORPO: nylon 6/6 UL94V-2
TEMPERATURA DI LAVORO: 120° C

Art.	A	Art.	A
G-CS5	5	G5220	22,2
G-CS10	10	G-CS28	28,5
G5215	12,2	G5225	32,2
G-CS13	12,7	G-CS35	35
G-CS19	19,1		

* minimo ordinabile 100 pezzi escluso stock

Supporti reggischeda RICHCO

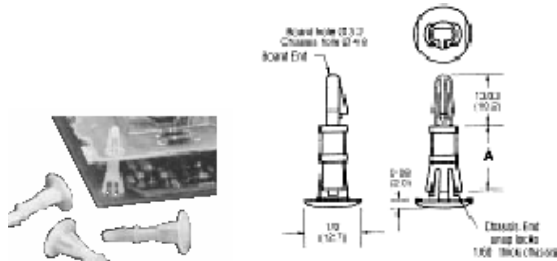

CORPO: nylon 6/6 UL94V-2

Art.	A	Art.	A
G-RLCBSRE40164	6.4	G-RLCBSRE801127	12,7
G-RLCBSRE60195	9.5		

* minimo ordinabile 1000 pezzi escluso stock

Supporti reggischeda filettati RICHCO

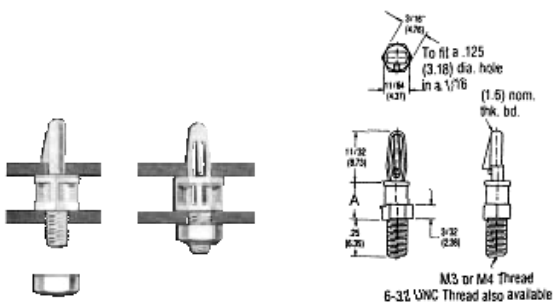

CORPO: nylon 6/6 UL94V-2

M3	A	M4	A
Art. G-MCBSMM3401635	6,35	Art. G-MCBSMM3401635	6,35

* minimo ordinabile 1000 pezzi escluso stock

Distanziali e minuterie

Supporti reggischeda filettati RICHO

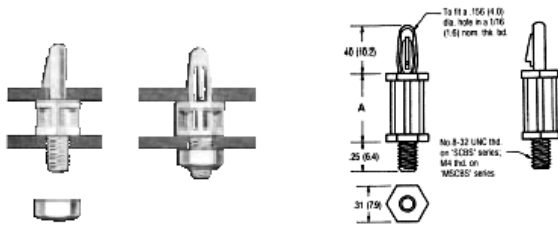

CORPO: nylon 6/6 UL94V-2

Art.	A	Art.	A
G-MSCBS40164	6,4	GB2340	15,9
G5214	9,5	G-MSCBS1201191	19,1

* minimo ordinabile 1000 pezzi escluso stock

Supporti reggischeda filettati RICHO

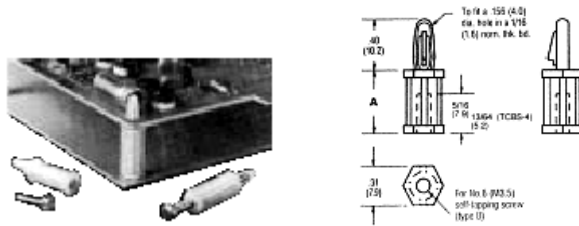

CORPO: nylon 6/6 UL94V-2

Art.	A	Art.	A
G-TCBS40164	6,4	G-TCBS1201191	19,1
G-TCBS60195	9,5	G-TCBS1401222	22,2
G-TCBS801127	12,7	G-TCBS1801286	28,6
G-TCBS1001159	15,9		

* minimo ordinabile 1000 pezzi escluso stock

Supporti reggischeda filettati

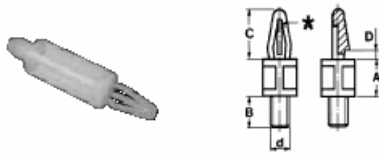

CORPO: nylon 6/6 UL94V-2

Art.	A	B	C	d	D
G-53721205	10,5	6,35	10	M4X0.7	1.6
G-53722205	20	6,35	10	M4X0.7	1.8

* minimo ordinabile 1000 pezzi escluso stock

Supporti reggischeda filettati RICHO

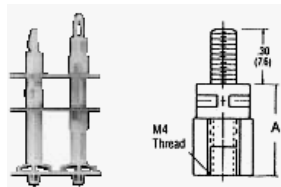

CORPO: nylon 6/6 UL94V-2

Art.	A
G-CBSTFMM460195	9,5

* minimo ordinabile 1000 pezzi escluso stock

Supporti reggischeda filettati RICHO

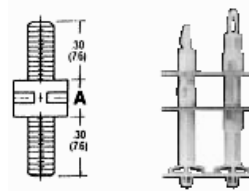

CORPO: nylon 6/6 UL94V-2

Art.	A	Art.	A
G-CBSTMMM440164	6,4	G-CBSTMMM41201191	19,1
G-CBSTMMM460195	9,5		

* minimo ordinabile 1000 pezzi escluso stock

Supporti reggischeda RICHO

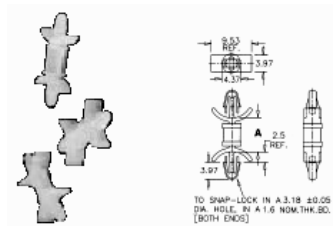

CORPO: nylon 6/6 UL94V-2

Art.	A	Art.	A
G-DLCBSM30148	4,8	G-DLCBSM40164	6,4

* minimo ordinabile 1000 pezzi escluso stock

Supporti reggischeda RICHO

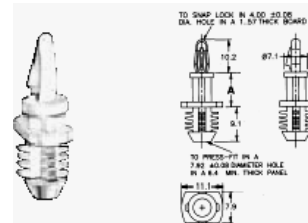

CORPO: nylon 6/6 UL94V-2

Art.	A	Art.	A
G-BHL30148	4,8	G-BHL40164	6,4

* minimo ordinabile 1000 pezzi escluso stock

Supporti reggischeda RICHO

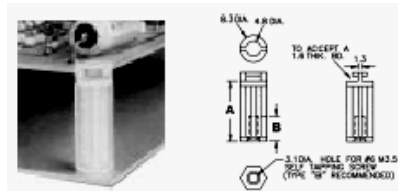

CORPO: nylon 6/6 UL94V-2

Art.	A	B
G-TCEHCBS40164	6,4	5,2

* minimo ordinabile 1000 pezzi escluso stock

Distanziali e minuterie

Distanziatori con autoritenuta RICHCO

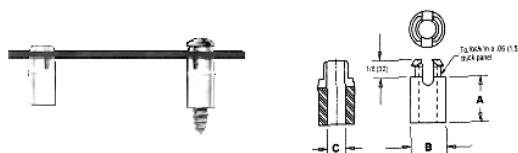

CORPO: nylon 6/6 UL94V-2

Vite	B	C	Ø hole
M-3	6.8mm	3,1mm	4,7mm

Art.	A	Art.	A
G-SRS420132	3,2	G-SRS460195	9,5
G-SRG440164	6,4	G-SRS4801127	12,7

* minimo ordinabile 1000 pezzi escluso stock

Vite	B	C	Ø hole
M-3.5	7,1mm	3,9mm	5,9mm

Art.	A	Art.	A
G-SRS640164	6,4	G-SRS6801127	12,7

* minimo ordinabile 1000 pezzi escluso stock

Vite	B	C	Ø hole
M-4	7,1mm	4,3mm	5,9mm

Art.	A
G-SRS840164	6,4

* minimo ordinabile 1000 pezzi escluso stock

Supporti reggischeda RICHCO

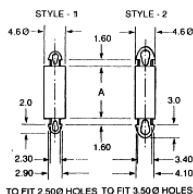
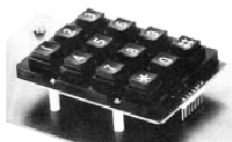

CORPO: nylon 6/6 UL94V-2

STYLE 1

Art.	A	Art.	A
G-MDLS110002M0120	2	G-MDLS1100012M01120	12
G-MDLS110004M0140	4	G-MDLS1100014M01140	14
G-MDLS110006M0160	6	G-MDLS1100016M01160	16
G-MDLS110008M0180	8	G-MDLS1100022M01220	20
G-MDLS1100010M01100	10		

* minimo ordinabile 1000 pezzi escluso stock

STYLE 2

Art.	A	Art.	A
G-MDLS213812M01120	12		

* minimo ordinabile 1000 pezzi escluso stock

Supporti reggischeda in nylon RICHCO

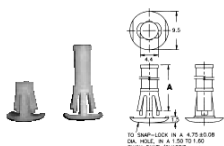

CORPO: nylon 6/6 UL94V-2

Art.	A
G-RLCBSRS1001159	15.9

Supporti reggischeda RICHCO

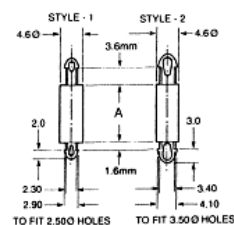
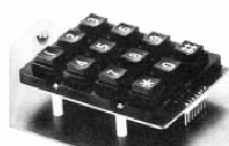

CORPO: nylon 6/6 UL94V-2

STYLE 1

Art.	A	Art.	A
G-MDLSPK110002M0120	2	G-MDLSPK110016M01160	16
G-MDLSPK110004M0140	4		

* minimo ordinabile 1000 pezzi escluso stock

Distanziali esagonali in nylon M3 femmina-femmina



CORPO: nylon 6/6 UL94V-2

Art.	A	Art.	A
G-HTP306	6	G-HTP318	18
G-HTP308	8	G-HTP320	20
G-HTP310	10	G-HTP322	22
G-HTP312	12	G-HTP325	25
G-HTP315	15	G-HTP330	30

* minimo ordinabile 100 pezzi escluso stock

Distanziali esagonali in nylon Maschio-maschio



CORPO: nylon 6/6 UL94V-2

M3

Art.	A	Art.	A
G-HTS306	6	G-HTS318	18
G-HTS308	8	G-HTS320	20
G-HTS310	10	G-HTS322	22
G-HTS312	12	G-HTS325	25
G-HTS315	15	G-HTS330	30

* minimo ordinabile 100 pezzi escluso stock

M4

Art.	A	Art.	A
G-HTS410	10,1	G-HTS419	19
G-HTS413	13	G-HTS425	25
G-HTS415	15		

* minimo ordinabile 100 pezzi escluso stock

Distanziali e minuterie

Viti in nylon



CORPO: nylon 6/6 UL94V-2

Vite	A	H	J	T
M-3	5,5	2	1	1,3

Art.	L	tipo	Art.	L	tipo
G-D030MA06	6	M3X0.5X0.6	G5247	16	M3X0.5X16
G-D030MA08	8	M3X0.5X0.8	G-D030MA20	20	M3X0.5X20
G-D030MA10	10	M3X0.5X10	G-D030MA25	25	M3X0.5X25
G-D030MA12	12	M3X0.5X12			

* minimo ordinabile 500 pezzi escluso stock

Vite	A	H	J	T
M-4	7	2,6	1,2	1,6

Art.	L	tipo	Art.	L	tipo
G-D040MA08	8	M4X0.8X0.8	G-D040MA35	35	M4X0.8X35
G-D040MA12	12	M4X0.8X12			

* minimo ordinabile 1000 pezzi escluso stock

Viti a testa cilindrica in nylon

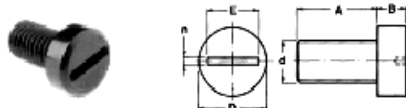

CORPO: nylon 6/6 UL94V-2

Art.	A	B	D	d	E	n
G-518312005	20	3.3	8.5	M5x0.8	6	14
G-517712005						

* minimo ordinabile 1000 pezzi escluso stock

dadi in nylon

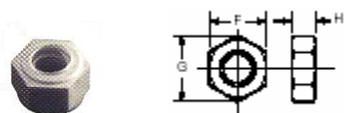

CORPO: nylon 6/6 UL94V-2

Art.	tipo	F	G	H
G5246	M3X0.5	5,4	6,2	2,2
GDAD/4MM	M4X0.7	6,9	7,9	3

* minimo ordinabile 500 pezzi escluso stock

Viti taglio cacciavite in ferro zincato filettate 3MA



Art.
G-VITE5
G-VITE7
G-VITE10

L
5 mm
7 mm
10 mm

Viti a croce in ferro zincato filettate 3MA

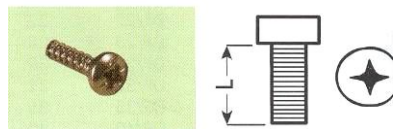

Art.
G-VTC6
G-VTC8
G-VTC10

L
6 mm
8 mm
10 mm

Viti autofilettanti a croce in ferro zincato filettate 3MA

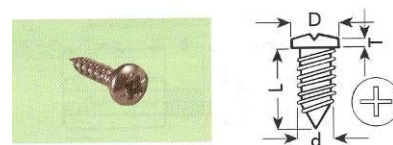

Art.
G-VA2
G-VA4
G-VA6
G-VA8

D	L	d	T
4,2	6,5	2,2	1,8
4,2	13	2,2	1,8
5,6	6,5	2,9	2,2
5,6	16	2,9	2,2

dado in ferro zincato

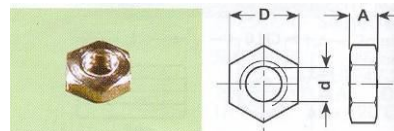

Art.
G-DADO3
G-DADO4
G-DADO5
G-DADO6

D	A	d
5,5	2	M3
7	2,8	M4
8	3,5	M5
10	4	M6

Grani filettati in nylon



Art.	d	E	L	n
G-517841025	M4X0.7	3	10	0.7
G-50744425	M4X0.7	2	4	0.8
G-5068629	M6X1	3.4	6.9	1.5
G-5068829	M6X1	3.4	8	1.5
G-50681026	M6X1	3.4	10	1.5
G-54081026	M7X1	5	10	1.3
G-50881119	M8X1.25	5.3	8	1.5
G-508819	M8X1.25	5.3	11	1.5
G-50881129	M8X1.25	5.8	11	1.8

* minimo ordinabile 500 pezzi escluso stock

Distanziali e minuterie

Rivetto a strappo in lega di alluminio

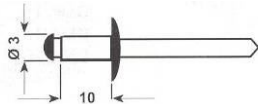

Art.
G-RIV103

nipplo in nylon

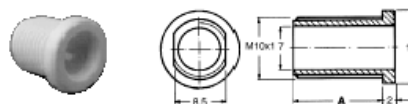

Art.	A	B	C	D	d	E
G-5016321526	15	2	12	M10X1	7	8.5

* minimo ordinabile 1000 pezzi escluso stock

Dadi metrici in nylon

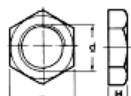

Art.	C	d	H
G-535526	8	M6X0.75	2
G-553926	13.8	M10X1	3
G-543726	17	M14X1	4

* minimo ordinabile 1000 pezzi escluso stock

nipplo in nylon

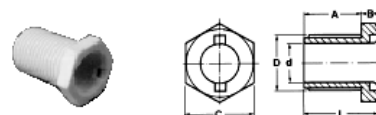

Art.	A	B	C	D	d	E
G-5016321526	15	2	12	M10X1	7	8.5

* minimo ordinabile 1000 pezzi escluso stock

Dadi con rondella in nylon

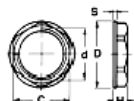

Art.	C	D	H	d	S
G-5436426	15	18	4	M12X1	1

* minimo ordinabile 1000 pezzi escluso stock

Supporti P.C.B in nylon

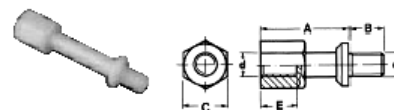

Art.	A	B	C	d	E
G-54143106	10	5	5.5	M3X0.5	5.5
G-54141006	10	6	7	M4X0.7	6.5
G-54141506	15	6	7	M4X0.7	6.5
G-54142006	20	6	7	M4X0.7	6.5
G-54142506	25	6	7	M4X0.7	6.5
G-54143006	30	6	7	M4X0.7	6.5

* minimo ordinabile 1000 pezzi escluso stock

Ghiere filettate in nylon

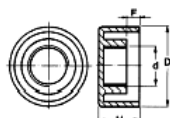

Art.	D	d	E	H
G-5171026	19	M10X1	3	9.5

* minimo ordinabile 1000 pezzi escluso stock

Passacavi adesivi in nylon

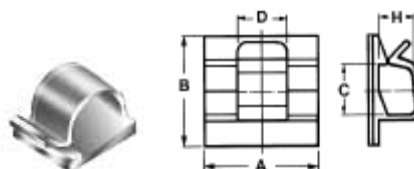

Art.	A	B	C	D	H
G-55111015	19	19	4.5	10	5
G-D3011	25	25	18	16	13
G-55111615	26	26	18	16	15

* minimo ordinabile 1000 pezzi escluso stock

Ghiere filettate in nylon

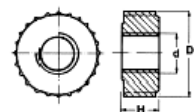

Art.	D	d	H
G-5211126	13	M5X0.8	5.2

* minimo ordinabile 1000 pezzi escluso stock

Fermacavi adesivi per cavo piatto in nylon

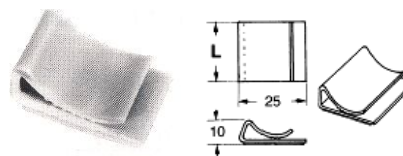

Art.	L (mm)
G-FC20	20
GA/FC25	25
G-FC28	28

* minimo ordinabile 100 pezzi escluso stock

sottotesta in nylon per viti T.C. – T.S.

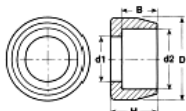

Art.	D	d1	d2	B	H
G-5397425	9.8	4.2	7.2	7.41	3

* minimo ordinabile 1000 pezzi escluso stock

Distanziali e minuterie

Basette adesive per fascette in nylon

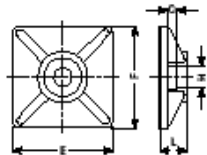

Art.
GBAS/AD19X19
G-HC101
GBAS/AD26X26
GBAS/FTH72A

formato
19X19
21X21
26X26
28X28

* minimo ordinabile 100 pezzi escluso stock

Supporti reggicavo in nylon

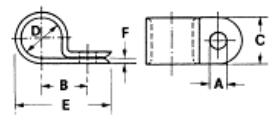

Art.	A	B	C	D	E	F
G-UC05	4.6	10.5	9.6	4.8	19.8	1.4
G-UC1	4.6	12	10	6.35	22	1.4
G-UC15	4.6	12	10	7.9	22	1.5
G-UC2	4.6	15.2	12	9.5	24	1.5
G-UC3	4.6	12.5	12	12.7	31	1.5
G-UC7	4.6	26.2	12	31.8	46.2	1.8

* minimo ordinabile 1000 pezzi escluso stock

Supporto per fascetta 4.8mm ad 1 foro in nylon T&B

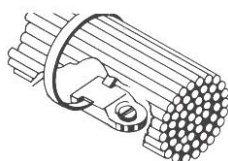

Art.
ATC812

Supporto per fascetta 4.8mm ad 1 foro ad angolo in nylon T&B

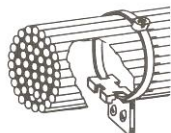

Art.
ATC109

Supporto impilatore per fascetta 4.8mm ad 1 foro in nylon T&B

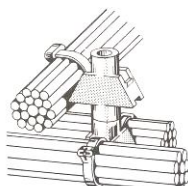

Art.
ATC115

Piastrina identificazione per fascetta 4.8mm Diametro cavi minimo 10mm in nylon T&B



Art.
ATC224

Supporti reggicavo in nylon adesivi

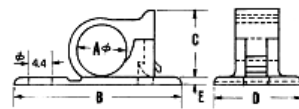

Art.	A	B	C	D	E
G-4JS	6	25.8	9.1	13.4	2

* minimo ordinabile 100 pezzi escluso stock

Supporti reggicavo in nylon adesivi

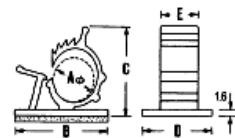

Art.	A	B	C	D	E
G-AP0810	7.9-10.3	25.4	22.2	19.1	10.2
G-AP1013	10-12.5	31.8	27.8	19.1	10.2
G-AP1316	12.6-15.4	38.1	31.8	19.1	10.7

* minimo ordinabile 100 pezzi escluso stock

Morsetti per cavi in nylon



Art.	AWG	Ø1	Ø2	Ø3	E	F
G-UC05	4.6	10.5	9.6	4.8	19.8	1.4
G-UC1	4.6	12	10	6.35	22	1.4
G-UC15	4.6	12	10	7.9	22	1.5

* minimo ordinabile 100 pezzi escluso stock

Distanziali e minuterie

Morsetti per cavo con molla in nylon

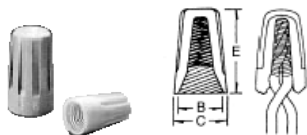

Art.	Cavo min.	Cavo max.	B	C	E
G-SW71B	20X1-22X1	16X2	6.5	8.7	15
G-SW72B	20X3	16X3	7.5	10	18
G-SW73B	20X3	16X3-18X1	9.5	11.2	23

* minimo ordinabile 100 pezzi escluso stock

pressacavi in nylon con serracavo filettatura PG senza rondella

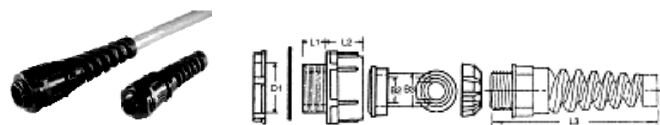

Art.	D1	B2	B3	L1	L2	L3	range
GGPG2013	20	9	13	13	19	78	6-13

Serracavi in nylon UL94V-2



per cavo piatto

Art.	Cavo UL	size	A	B	C	T
G-SRF21	SPT-1	2.3X4.5-2.8X5.3	9.5	8.7	10.3	0.5-1.6
G-SRF23	SPT-1	2.3X4.5-2.8X5.3	9.5	8.7	10.3	1.8-3.2
G-SRF31	SPT-1	3X5.6	11	9.9	10.3	1-1.6
MG1300	-	-	11	-	-	1-1.6
G-SRF32	SPT1 SPX1	3X5.6	11	9.9	10.3	1.9-2.5
G-SRF41	SPT-218	3X7.1-3.8X7.6	12.7	11.8	10.3	0.5-1.6
G-SRF42	SPT-2	3X7.1-3.8X7.6	12.7	11.8	10.3	1.8-2.5
MG1305	-	-	14.3	-	-	1.9-2.5
G-SRF51	SPT-3	5X10.4	14.3	13.2	15.2	0.5-1.6
G-SRF53	SPT-3	5X10.4	13.2	13	15.2	1.8-3.5

* minimo ordinabile 1000 pezzi escluso stock

pressacavi in nylon IP68 filettatura metrica

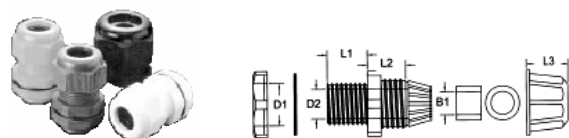

Art.	D1	P	D2	B1	L1	L2	L3	range
G-AG12	12	1.25	8.3	5	7.9	12.1	13.3	3-6.5
G-AG16	16	1.5	10.9	9.6	14.4	14.4	16.7	5-10
G-AG20	20	1.5	14.8	12.9	12.8	19.5	18.4	10-14
G-AG25	25	1.5	18.5	16.5	13.9	19.5	22.3	13-18
G-AG32	32	1.5	25.9	23.3	14.6	20.3	26.1	18-25
G-AG40	40	1.5	31.4	30.6	17.7	23.4	31.9	22-32
G-AG50	50	1.5	41.2	38.2	17.3	25.7	31.6	30-38
G-AG63	63	1.5	54.1	42.4	18.6	26.2	32.6	34-44

* minimo ordinabile varia da 10 pezzi a 50 pezzi escluso stock

pressacavi in nylon IP68 filettatura PG senza rondella

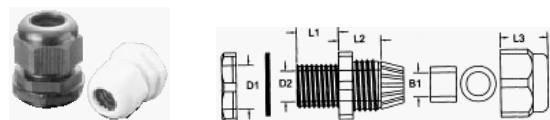

Art.	D1	P	D2	B1	L1	L2	L3	range
G-EG7	PG7 12.1	1.5	8	6	8	12.8	13.4	3.5-6
G-EG9	PG9 14.3	1.5	9.9	7	8.1	13.9	15.2	4-8
G-EG11	PG11 18.23	1.5	13.2	9.6	8.2	15.4	18.3	5-10
G-EG13.5	PG13.5 19.9	1.5	15.2	11.7	8.9	15.8	18.9	6-12
G-EG16	PG16 22.1	1.5	17.2	12.9	8.9	17.3	19.7	10-14
G-EG21	PG21 27.5	1.5	22.4	16.5	10.8	18.6	23.9	13-18
G-EG29	PG29 36.2	1.5	30.6	23.3	10.9	20.5	27.4	18-25
G-EG36	PG36 46.7	1.5	35.2	33.3	14.4	24.4	30.5	22-32

* minimo ordinabile varia da 10 pezzi a 50 pezzi escluso stock

pressacavi in nylon con serracavo filettatura PG senza rondella



Art.	D1	P	D2	B1	L1	L2	L3
G-EG7SR	12.1	1.5	7.6	5.9	7.9	12.4	53.3
G-EG135SR	19.8	1.5	15	11.5	8.9	11.9	85.5
G-EG16SR	22.1	1.5	17.2	12.8	9.8	18.5	97
G-EG21SR	27.7	1.5	22.3	16.2	10.3	19.8	111.2

per cavo tondo

Art.	Cavo UL	size	A	B	C	T
G-SR5R1	SVI,SVT	6.2-7.4	12.7	11.5	11	0.5-1.6
G-SR5R2	SVI,SVT	6.2-7.4	12.7	11.5	11	1.8-2.5
G-SR6W2	SVI,SVT	7.6	12.7	11.8	11	1.8-2.3
G-SR6P1	SJC3C-18	7.4-8.2	15.9	14	14.8	0.5-1.6
G-SR6P3	SJC3C-18	7.4-8.2	15.9	14	14.8	1.9-3.2
G-SR6R1	SJ,SJT,3C	8.2-9.2	15.9	14	14.8	0.5-1.6
G-SR6R3	SJ,SJT,3C	8.2-9.2	15.9	14	14.8	1.9-3.2
G-SR7R1	SJT,3C-14	9.2-10.5-11	19-19.8	16.5	19	0.5-1.6
G-SR7R3	SJT,3C-14	9.2-10.5-11	19-19.8	16.5	19	1.9-3.2
G-SR9R1	20-30PCS	11-15	19	19	17.5	0.5-1.6

* minimo ordinabile 1000 pezzi escluso stock

Passacavi in nylon

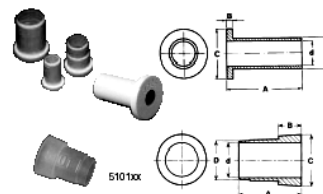

Art.	A	B	C	D	d
G-5037020	10	1	11.5	8	5.5
G-503710	10	1.7	11	7	5.6
G-510100*	10.5	1.6	9	7	5.9
G-510120	10.5	1.6	9	7	5.9

* minimo ordinabile 1000 pezzi escluso stock

*colore neutro

Distanziali e minuterie

Gommini passacavo



Art.	A	B	D	d	H
G-6237421	6	3	10	4	7
G-6233521	9	2	14	5	8
G-622121	8	2.5	12	5	7
G-6235521	8	3.5	12	5	7.5
G-620121	8	1	14	6	6
G-6235621	8	3.5	12	6	7.5
G-6202721	11	1.5	15	7	7.5
MG547	9	2	14	7	8
G-6205721	11	0.5	16	7	6
MG571	-	2	14.5	4	-
G-6204821	11.5	3	14.5	8	11
G-622221	10	1.5	14.5	8	6
MG555	-	3	14.5	9	-
G-6204921	11.5	3	14.5	9	11
G-6203911	12	1.5	17.5	9	7
G-6203921	12	1.5	17	9	7
G-622201021	13.5	2	17.5	10	7
G-62151021	15	1.5	18.5	10	8
G-62381221	18	2	23	12	8
G-62151321	15	1.5	18.5	13	8
MG579	-	2	23	10	-
G-62381421	18	2	23	14	8
G62111621	21	2	28	16	8
G-62381621	18	2	23	16	8
G-62252021	24	2	32	19.5	8.5

* minimo ordinabile 1000 pezzi escluso stock

Gommini passacavo

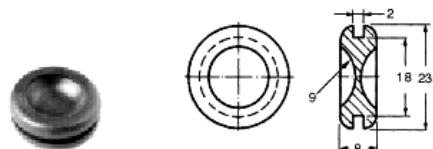

Art.
G-625421

* minimo ordinabile 1000 pezzi escluso stock

Gommini passacavo

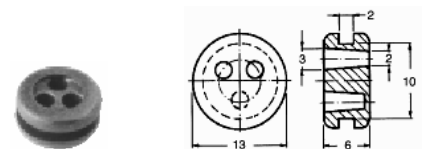

Art.
G-63070121
G-63070221
G-63070321

Fori chiusi
1
2
3

* minimo ordinabile 1000 pezzi escluso stock

passacavo

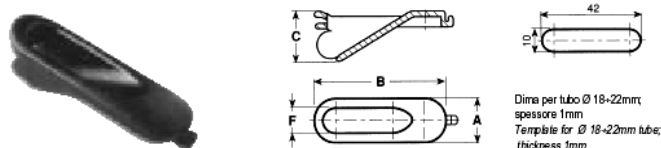

Dimi per tubo Ø 18-22mm;
spessore 1mm
Template for Ø 18-22mm tube;
thickness 1mm

Art. **G-54385120**

* minimo ordinabile 1000 pezzi escluso stock

Ghiere bloccacavi in nylon

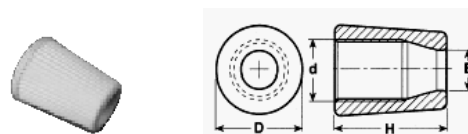

Art.	D	d	E	F	colore
G-590516	14.8	M10X1	6.5	18.5	bianco
G-590526	14.8	M10X1	6.5	18.5	nero
G-590546	14.8	M10X1	6.5	18.5	oro

* minimo ordinabile 1000 pezzi escluso stock

bloccacavo

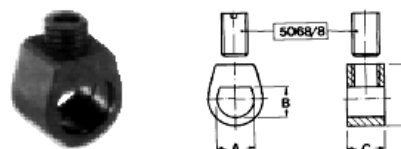

Art.	A	B	C	D	colore
G-522726	9	7.5	8.3	14	Nylon nero
G-5227218	9	7.5	8.3	14	Polibutil nero

* minimo ordinabile 1000 pezzi escluso stock

bloccacavo

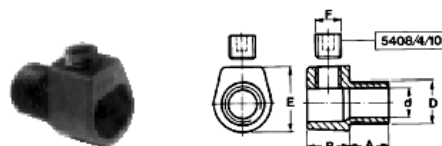

Art.	A	B	D	d	E	F	colore
G-510070526	5	10	M10X1	7.2	16	M7X1	Nylon nero
G-510070526	8	10	M10X1	7.2	16	M7X1	Nylon nero

* minimo ordinabile 1000 pezzi escluso stock

bloccacavo

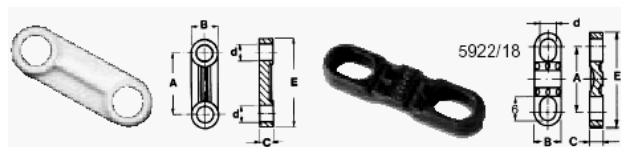

Art.	A	B	C	d	E	colore
G-592226	16	7	4	4.2	23	Nylon nero
G-59221726	18	6.2	4	4	26	Nylon nero
G-59221826	18	7	3	3.9	26	Nylon nero

* minimo ordinabile 1000 pezzi escluso stock

Distanziali e minuterie

bloccacavi



Art.	B	D	E	H
G-54620425	28.5	4	20	14

* minimo ordinabile 1000 pezzi escluso stock

Tappi a scatto ciechi autobloccanti



Art.	Foro Ø	dimensioni
GTAP/SHP189	6.35mm	10.5mm
GTAP/SHPB78	6.35mm	10mm
GTAP/SHP567	8mm	13.5mm
GTAP/SHP991	13mm	17.5mm

bloccacavi

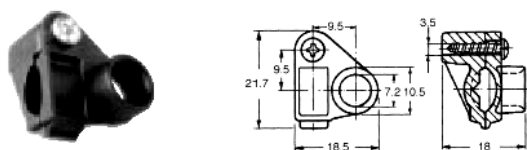

Art.
G-5463725

* minimo ordinabile 1000 pezzi escluso stock

tappi

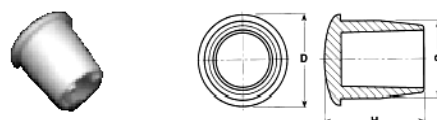

Art.	D	d	H
G-508125	10	8	7
G-54531320	13	10.8	14
G-54531620	16	13.5	18

* minimo ordinabile 1000 pezzi escluso stock

Pomelli filettati

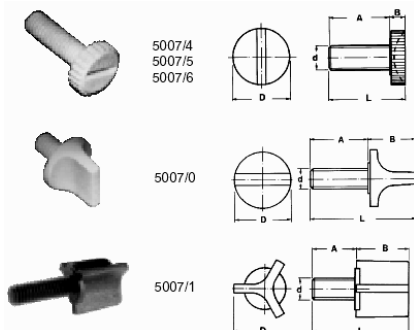

Art.	A	B	D	d	L
G-500741026	10	3.8	13	M4X0.7	13.8
G-500741516	15	3.8	13	M4X0.7	18.8
G-500752026	20	3.8	13	M5X0.8	23.8
G-500761026	10	3.8	13	M6X1	13.8
G-5007041016	10	12	15	M4X0.7	22
G-500761026	10	13	15	M6X1	23

* minimo ordinabile 1000 pezzi escluso stock

tappi



Art.	D	d	H	s	colore
G-630311	25	19	7	2.4	Bianco
G-630321	25	19	7	2.4	nero

* minimo ordinabile 1000 pezzi escluso stock

tappi

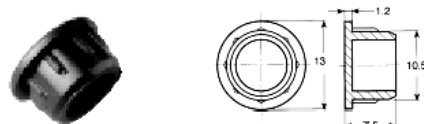

Art.	colore
G-529310	Bianco
G-529320	nero

* minimo ordinabile 1000 pezzi escluso stock

Tasselli distanziatori



Art.	Foro Ø	dimensioni
GTAS/SGNB40	2 mm	9X9
GTAS/SGN216	3 mm	10X10
GTAS/SGN535	2.5 mm	10X10

Paracolpi in gomma adesivi



Art.	altezza	dimensioni
GPIE/492	1mm	Ø12mm
GPIE/489	4mm	Ø11mm
GPIE/497	2mm	Ø11mm
GPIE/757	9mm	Ø11.5mm
GPIE/490	5mm	Ø11.5mm
GPIE/500	2mm	11x11mm
GPIE/499	3mm	13X13mm

Distanziali e minuterie

Piedini in gomma

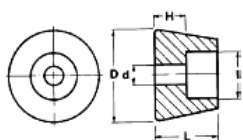
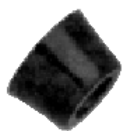

Art.	D	d	H	I	L
G-501806	11	3.5	2	6	7.5
G-50181306	11	3.5	2	6	13
G-5030426	15	6	2	10	6.3
G-6512321	19	3	6.5	9.5	13
G-6512421	19	4	6.5	9.5	13

* minimo ordinabile 1000 pezzi escluso stock

Piedini in gomma

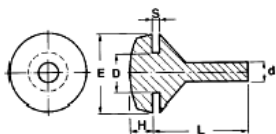

Art.	D	d	E	H	L	S
G-630421	6	3	12	3.5	15	1.2

* minimo ordinabile 1000 pezzi escluso stock

Piedini in gomma

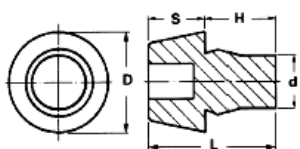

Art.	D	d	H	L	S
G-501806	10	6	7.5	10.5	3

* minimo ordinabile 1000 pezzi escluso stock

Rondelle in nylon

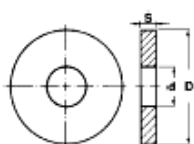

Art.	D	d	S
G-5515105	4.5	2.4	1
G-5515205	4.5	2.4	2
G-55210410	7	2.5	1
G-5516205	5	2.7	2
G-5021106	7	3.2	1
G-5021116	7	3.2	1
G-5021126	7	3.2	1
G-5021206	7	3.2	2
G5021-35-1	7	3.5	1
G-DIS/5093	8	3.6	1
G-5098361200	8	3.6	1.2
G-503635106	14	3.7	1.2
GDIS/5015	10	4.3	1
G-50154226	10	4.3	2
G-530241505	12	4.3	1.5
GDIS/5036/3/5/1	14	3.5	1.2
G-50365106	14	5	1

* minimo ordinabile 1000 pezzi escluso stock

Art.	D	d	s
G-50365306	14	5	3
G-5301106	10	5.3	1
G-50156126	10	6	1
G-50366226	14	6.4	2
G-50367226	14	7	2
G-50368226	14	8	2
G-53008105	17	8	1

* minimo ordinabile 1000 pezzi escluso stock

Rondelle in nylon

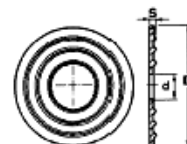

Art.	D	d	s
G-50261	22	10.5	2
G-50356	30	10.5	2

* minimo ordinabile 1000 pezzi escluso stock

Isolatori in nylon

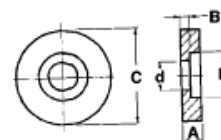

Art.	A	B	C	D	d
G-532302405	4	2	10	6.2	5.3
G-552302500	5	2	10	6.2	5.3

* minimo ordinabile 1000 pezzi escluso stock

Isolatori in nylon

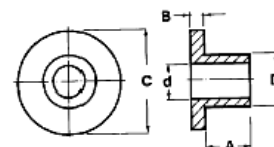

Art.	A	B	C	D	d
G-55241026	10	2	11	7.5	4.1
G-53231205	2	1	10	6.2	5.3
G-53231405	4	1	10	6.2	5.3
G-53233625	6	3	10	6.2	5.3
G-53233400	4	3	10	6.2	5.3
G-53232525	5	2	10	6.2	5.3
G-53233726	7	3	10	6.2	5.3
G-61182126	2	1	20	9.8	6.3

* minimo ordinabile 1000 pezzi escluso stock

Isolatori in nylon

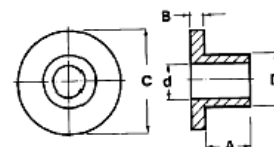

Art.	A	B	C	D	d
G-51601206	1.2	1.2	6.4	3.6	3
G-51602306	2.3	1.2	6.4	3.6	3
G-51604006	4	1.2	6.4	3.6	3
G-610406	7	2.5	13.8	5	3.3
G5451118	1.25	1.25	9.2	6.4	4.1

* minimo ordinabile 1000 pezzi escluso stock

Distanziali e minuterie

Fascette autobloccanti in nylon



colore naturale

Art.	L	larghezza	∅ fascio	Rtr.
G-CV075K	75	2.4	18	8
G6575	85	2.2	18	8
G6495	100	2.5	25	8
G-CV120SK	120	2.5	30	8
G-CV120K	120	3.2	30	18
G-CV120SK	142	2.5	35	8
G-CV140K	142	3.2	35	18
G-CV150K	150	3.6	39	18
G-CV165K	165	2.5	44	8
G-CV180K	180	4	49	22
G-CV190K	190	4.8	52	22
G6561	200	2.5	55	8
G-CV200MK	203	2.5	55	8
G-CV200SK	203	3.2	55	18
G-CV200K	203	4.6	55	22
G-CV250MK	250	3.6	74	18
G-CV292	292	3.6	85	18
G-CV300	300	7.6	88	55
G-CV310	310	4.8	89	22
G-CV368S	368	3.6	102	22
G6570	370	3.6	102	22
G-CV400S	400	2.5	117	8
G-CV432	432	4.8	125	22
G-CV550	550	8	166	80

* minimo ordinabile 1000 pezzi escluso stock – dal G-CV250MK 100 pezzi

colore nero

Art.	L	larghezza	∅ fascio	Rtr.
GFASC/98/2.5	98	2.5	21	8
GFASC/130/2.5	130	2.5	32	8
GFASC/140/3.6	140	3.6	35	13
GFASC/160/2.5	160	2.5	40	8
GFASC/200/2.5	200	2.5	52	8
GFASC/300/3.6	300	3.6	80	13

* minimo ordinabile 1000 pezzi escluso stock

Fascette a grani in nylon colore naturale

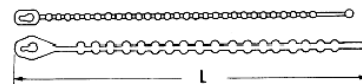

Art.	L	∅ fascio	Rtr.
G-TV120	120	30	8
G-TV150	150	39	14
G-TV280	280	75	22

* minimo ordinabile 1000 pezzi escluso stock

Fascette con fissaggio in nylon

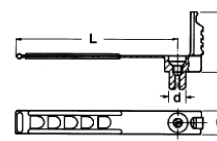

Art.	B	d	C	L
G-531205	23	6.8	62	8

* minimo ordinabile 250 pezzi escluso stock

Fascette riutilizzabili

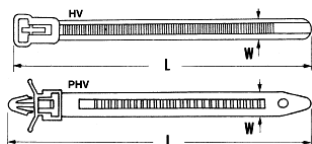
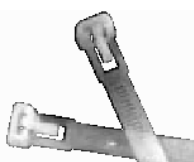

colore naturale

Art.	L	W	∅ fascio	Rtr.
G-HV125	125	7.6	30	22
G-HV200	200	7.6	50	22

* minimo ordinabile 1000 pezzi escluso stock