

PULSANTI E INTERRUTTORI A BASCULA

Pulsanti 1A 125V

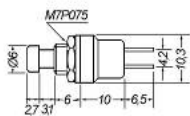

Corpo: termoplastico
Contatti: in ottone a saldare

NORMALMENTE APERTI

Art.
6001-0005
6001-0010

Colore tasto
Rosso
Nero

NORMALMENTE CHIUSI

Art.
6001-0015
6001-0020

Colore tasto
Rosso
Nero

Pulsanti 1A 150V

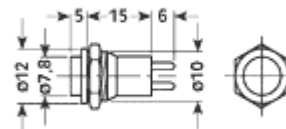

Corpo: termoplastico
Contatti: in ottone a saldare

NORMALMENTE APERTI

Art.
6001-0065
6001-0070

Colore tasto
Rosso
Nero

NORMALMENTE CHIUSI

Art.
6001-0055
6001-0060

Colore tasto
Rosso
Nero

Pulsanti normalmente aperti 1A125V

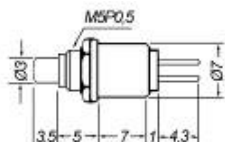

Corpo: termoplastico
Contatti: in ottone a saldare

Art.
6001-0035
6001-0040

Colore tasto
Rosso
Nero

Pulsanti normalmente aperti

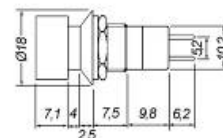

Corpo: termoplastico
Contatti: in ottone a saldare
Portata: 3A 125V

PULSANTE

Art.
6001-0135
6001-0130

Colore tasto
Rosso
Nero

Pulsanti normalmente aperti 1A125V

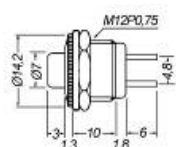

Corpo: termoplastico
Contatti: in ottone a saldare

Art.
6001-0045
6001-0050

Colore tasto
Rosso
Nero

INTERRUPTORE

Art.
6001-0145
6001-0140

Colore tasto
Rosso
Nero

Pulsanti 3A 125V

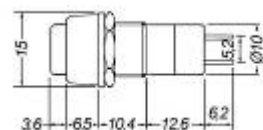

Corpo: termoplastico
Contatti: in ottone a saldare

PULSANTE

Art.
6001-0105
6001-0110

Colore tasto
Rosso
Nero

Pulsanti normalmente aperti 3A125V

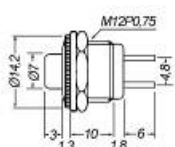

Corpo: termoplastico
Contatti: in ottone a saldare

Art.
6001-0075
6001-0080

Colore tasto
Rosso
Nero

INTERRUPTORE

Art.
6001-0115
6001-0120
6001-0121

Colore tasto
Rosso
Nero
Bianco

PULSANTI E INTERRUTTORI A BASCULA

Pulsanti luminosi 3A 125V

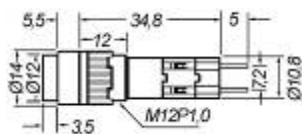

Corpo: termoplastico
Contatti: in ottone a saldare

DEVIATORE STABILE

Art. 6001-0150 Colore Rosso
6001-0155 Verde
6001-0160 Giallo

DOPPIO DEVIATORE MOMENTANEO

Art. 6001-0165 Colore Rosso
6001-0170 Verde
6001-0175 Giallo

Pulsanti luminosi 3A 125V

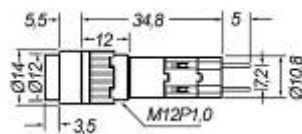

Corpo: termoplastico
Contatti: in ottone a saldare

DEVIATORE STABILE

Art. 6001-0180 Colore Rosso
6001-0185 Verde
6001-0190 Giallo

DOPPIO DEVIATORE MOMENTANEO

Art. 6001-0195 Colore Rosso
6001-0200 Verde
6001-0205 Giallo

Pulsanti 3A 125V

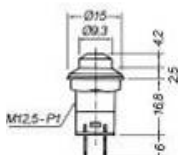

Corpo: termoplastico
Contatti: in ottone a saldare

PULSANTE

Art. 6001-0085 Colore Rosso
6001-0090 Verde

INTERRUTTORE

Art. 6001-0095 Colore Rosso
6001-0100 Verde

Pulsanti da pannello RAFI 0.7A 250V IP40 1 contatto di chiusura 1.10.001.001/0301

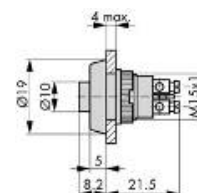

Corpo: termoplastico
Contatti: in ottone a saldare

Art. 6001-0125 Colore Rosso

pulsante luminosi RAFI per lente quadrata

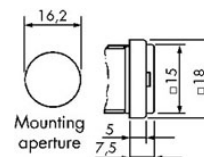

Corpo: termoplastico
Contatti: in ottone a saldare
Portata: 4A

AZIONAMENTO MOMENTANEO

Art.	Codice originale	poli
6001-0210	1.15.108.251/0000	1
6001-0215	1.15.108.257/0000	2

COMMUTAZIONE A RITENUTA

Art.	Codice originale	poli
6001-0220	1.15.351.251/0000	1
6001-0225	1.15.357.257/0000	2

Segnalatore RAFI per lente quadrata

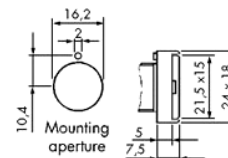

Corpo: termoplastico
Contatti: in ottone a saldare
Portata: 4A

Art.	Codice originale	lente
6001-0230	1.65.111.061/0000	18x18

PULSANTI E INTERRUTTORI A BASCULA

Lente colorata quadrata 18x18



Art.	Codice originale	lente
6001-0235	5.49.275.036/1002	trasparente
6001-0236	5.49.275.036/1303	rosso
6001-0237	5.49.275.036/1402	giallo
6001-0238	5.49.275.036/1502	verde
6001-0239	5.49.275.036/1503	Verde
6001-0240	5.49.275.036/1601	blu

Lente colorata rettangolare 18x24



Art.	Codice originale	lente
6001-0280	5.49.275.032/1002	trasparente
6001-0281	5.49.275.032/1303	rosso
6001-0286	5.49.275.032/1301	rosso
6001-0282	5.49.275.032/1402	giallo
6001-0283	5.49.275.032/1502	verde
6001-0284	5.49.275.032/1503	Verde
6001-0285	5.49.275.032/1601	blu

segnalatori luminosi RAFI per lente rettangolare

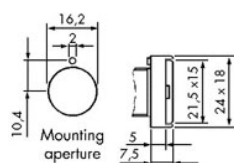

Corpo: termoplastico
Contatti: in ottone a saldare
Portata: 4A

Art.	Codice originale	lente
6001-0275	1.65.111.051/0000	18x24

pulsante luminosi RAFI per lente rettangolare ad azionamento momentaneo

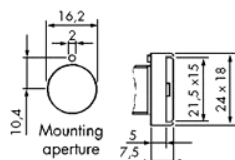

Corpo: termoplastico
Contatti: in ottone a saldare
Portata: 4A

AZIONAMENTO MOMENTANEO

Art.	Codice originale	poli
6001-0255	1.15.108.051/0000	1
6001-0260	1.15.108.052/0000	2

COMMUTAZIONE A RITENUTA

Art.	Codice originale	poli
6001-0265	1.15.108.151/0000	1
6001-0270	1.15.108.152/0000	2

Specola o inserto opaco 18x24



Art.	Codice originale	tipo
6001-0290	5.73.012.000/0214	Per led
6001-0295	5.73.012.000/0202	Per lampade

Interruttori a pulsante luminosi RAFI IP65

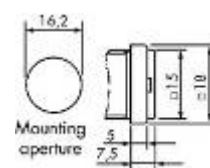

Corpo: termoplastico
Contatti: in ottone a saldare
Portata: 4A 250V

AZIONAMENTO MOMENTANEO

Art.	Codice originale	tipo	contatti
6001-0300	1.15.108.276/0000	19x19	2
6001-0305	1.15.108.076/0000	19x25	2

COMMUTAZIONE A RITENUTA

Art.	Codice originale	tipo	contatti
6001-0310	1.15.108.376/0000	19x19	2
6001-0315	1.15.108.176/0000	19x25	2

Lenti colorate rettangolari 19x25



Art.	Codice originale	lente
6001-0325	5.49.277.058/1002	trasparente
6001-0326	5.49.277.058/1303	rosso
6001-0327	5.49.277.058/1402	giallo
6001-0328	5.49.277.058/1502	verde

inserti scrittura

Art.	Codice originale	tipo
6001-0330	5.70.629.000/2000	Tasti quadrati
6001-0335	5.70.630.000/2000	Tasti rettangolari

PULSANTI E INTERRUTTORI A BASCULA

Lente quadrata trasparente



Art. **6001-0340** Codice originale 5.49.275.086/1002 tipo X 1.16.540.131/0000

Lampadine ad incandescenza telefonica T4,5



Art.	Codice originale	volt	mA
6001-0350	4516.00.006.050	6	50
6001-0356	4516.00.012.040	12	40
6001-0357	4516.00.024.020	24	20
6001-0358	4516.00.030.020	30	20

Led T,5



Art.	Codice originale	volt	colore
6001-0360	4510.02.2813.ER	24...28	Rosso
6001-0361	4510.02.2813.EY	24...28	Verde
6001-0362	4510.02.2813.EG	24...28	Giallo
6001-0363	4510.02.2813.EB	24...28	blu
6001-0364	4510.02.2813.WS	24...28	bianco

Interruttore bipolare luminoso a pulsante



Corpo: nylon rinforzato vetro
Contatti: in ottone a saldare
6A 250V
Cornice: 15X21

Art. **6001-0390** Foratura a pannello 19x13

Interruttori bipolari 3A 125VAC

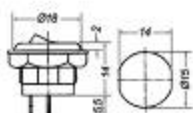

Corpo: nylon rinforzato vetro
Contatti: ottone argentato a saldare

CODICE	Colore	tipo
6001-0395	nero	ON-OFF 2 terminali
6001-0400	nero	ON-ON 3 terminali

Interruttore bipolare a pulsante 16A 250V

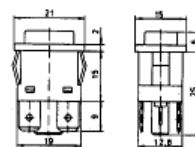

Corpo: policarbonato nero
Contatti: in ottone argentato faston 4.8mm

Art.	colore
G-I3950	nero
G-I3953	rosso
G-I3955	verde
G-I3952	giallo

Ordine minimo 100 pezzi escluso stock

Interruttori unipolari 6A 250VAC 15X21

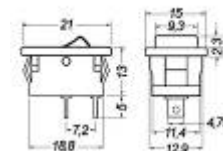

Corpo: nylon rinforzato vetro
Contatti: ottone argentato faston 4.8mm

CODICE	Colore	Cava	Tipo	pulsante
6001-0405	nero	18.8X12.9	ON-OFF	0
6001-0408	nero	18.8X12.9	ON-ON	0
6001-0410	nero	18.8X12.9	ON-ON	+-

Interruttori bipolari 6A 250VAC 15x21

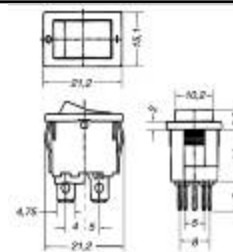

Corpo: nylon rinforzato vetro
Contatti: ottone argentato faston 4.8mm

CODICE	Colore	Tipo	pulsante
6001-0415	nero	ON-OFF	0-1

Interruttori bipolari 6A 250VAC 15x21



Corpo: nylon rinforzato vetro
Contatti: ottone argentato faston 4.8mm

CODICE	Colore	Cava pannello	pulsante
6001-0420	Rosso	13X19	ON-ON
6001-0421	Giallo	13X19	ON-ON
6001-0422	Verde	13X19	ON-ON

PULSANTI E INTERRUTTORI A BASCULA

Interruttore bipolare 10A 250V 15x21

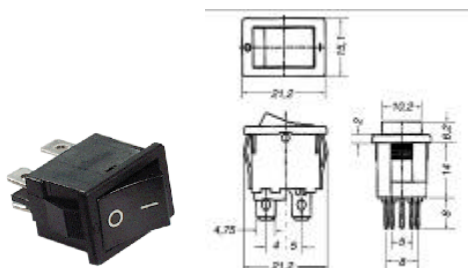

Corpo: nylon rinforzato vetro
Contatti: in ottone argentato
Per faston 4.8mm

CODICE	Colore	Cava pannello	tipo
6001-0425	Nero	13X19	ON-ON
6001-0426	Rosso	13X19	ON-ON
6001-0428	Rosso *	13X19	ON-ON
6001-0427	Verde	13X19	ON-ON

Interruttore a bilancere unipolare 10A 250V

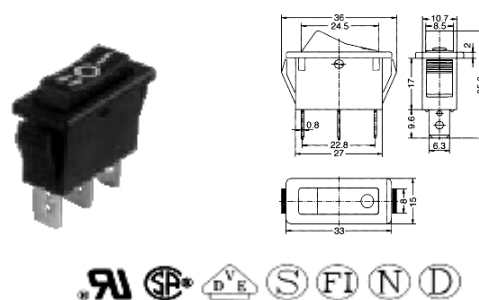

Corpo: nylon PA66
Contatti: in ottone
Per faston 4.8mm

Art.	descrizione
G-R412KKFTOF	Nero scritta bianca I - 0 ON-OFF
G-R432KKBTOF	Nero scritta bianca I - 0 - II ON-OFF-ON

Interruttore luminoso a bilancere unipolare 10A 250V ON-OFF

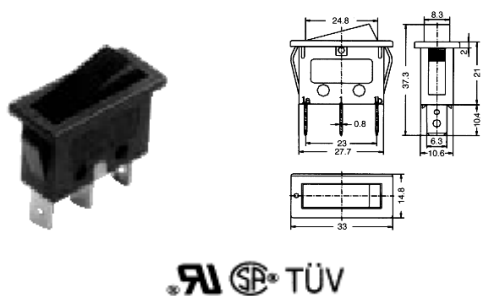

Corpo: nylon PA66
Contatti: in ottone
Per faston 4.8mm

Art.	colore
G-R392KDET2C	Nero scritta bianca I - II

Interruttore a bilancere unipolare 6A 250V

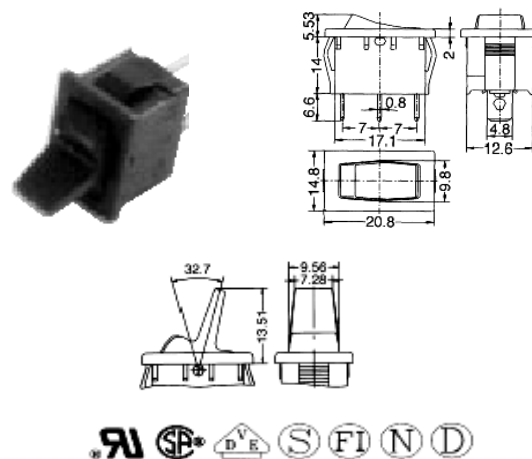

Corpo: nylon PA66
Contatti: in ottone
Per faston 4.8mm

Art.	descrizione
G-R12KKEPOF	Nero ON-OFF

Interruttore a bilancere unipolare 10A 250V

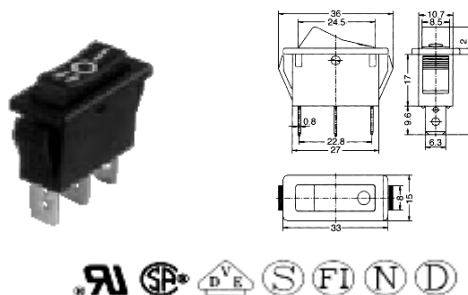

Corpo: nylon PA66
Contatti: in ottone
Per faston 4.8mm

Art.	descrizione
G-R412KKFTOF	Nero scritta bianca I - 0 ON-OFF
G-R432KKBTOF	Nero scritta bianca I - 0 - II ON-OFF-ON

PULSANTI E INTERRUTTORI A BASCULA

Interruttori a bilancere unipolari 6A 250V Terminali a 90° ON-OFF-ON

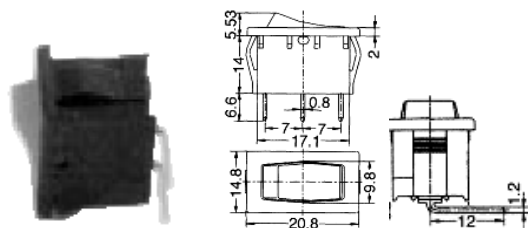

Corpo: nylon rinforzato vetro
Contatti: in ottone argentato

Art.
G-RA32KKEROF

colore
Nero

interruttore a bilancere bipolari 6A 250V

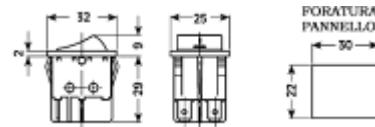

Corpo: nylon rinforzato vetro
Contatti: in ottone argentato
Per faston 4.8mm

CODICE 6001-0440	Colore Nero	Cava pannello 30X22	tipo ON-OFF
----------------------------	----------------	------------------------	----------------

interruttori a bilancere bipolari 16A 250V posizione 0 – 1 OMEGA

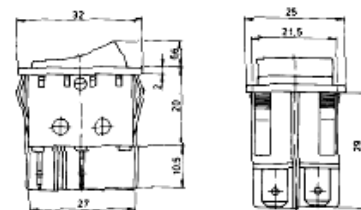

Corpo: poliammide 66 nera
Contatti: in ottone argentato
Per faston 6.3mm

Art. G-I4700 GI/4713 G-I4715 G-I4712 GI/4720 G-I4730	tipo ON-ON ON-OFF ON-OFF ON-OFF ON-OFF ON-OFF-ON	colore nero Rosso luminoso Verde luminoso Giallo luminoso nero nero
--	--	---

Ordine minimo 100 pezzi escluso stock

interruttori luminosi a bilancere unipolari 16A 250V

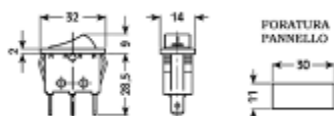

Corpo: nylon rinforzato vetro
Contatti: in ottone argentato
Per faston 6.3mm

CODICE	Colore	Cava pannello	tipo
6001-0430	Nero	30X11	ON-ON
6001-0431	Rosso	30X11	ON-ON
6001-0432	Rosso *	30X11	ON-ON
6001-0433	Verde	30X11	ON-ON

deviatori a bilancere bipolari 16A 250V

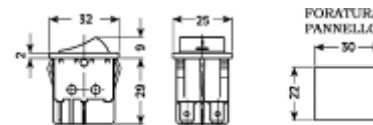

Corpo: poliammide 66 nera
Contatti: in ottone argentato
Per faston 6.3mm

CODICE	Colore	Cava	Tipo	Indicaz.tasto
6001-0445	Nero	30X22	ON-OFF	Bianca
6001-0446	Rosso	30X22	ON-OFF	Bianca
6001-0447	Verde	30X22	ON-OFF	Nera on-off
6001-0448	Verde	30X22	ON-OFF	Nera
6001-0449	Verde	30X22	ON-OFF	Bianca

PULSANTI E INTERRUTTORI A BASCULA

Cappucci di protezione IP54



Corpo: PVC
Colore: trasparente

Art.
6001-0450
6001-0451
6001-0452

Per interruttori
15X21
11X30
22X30

Interruttori luminosi con led a bilancere unipolari 3A 250V 0 – 1 OMEGA

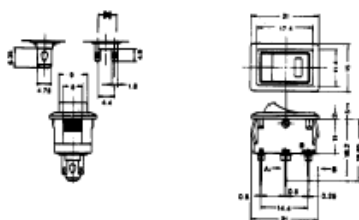

Corpo: nylon rinforzato vetro
Contatti: in ottone argentato

Art.
G-I3401
G-I3402
G-I3403

Tasto con led
arancio
verde
rosso

Ordine minimo 100 pezzi escluso stock

Interruttori a bilancere unipolari 5A 250V 0 – 1 OMEGA

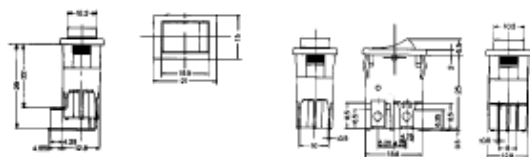

Corpo: nylon rinforzato vetro
Contatti: in ottone argentato
Colore: nero

Art.
G-I3401
G-I3402
G-I3403

terminali
Faston 4.8mm
Circuito stampato dritto
Circuito stampato a 90°

Ordine minimo 100 pezzi escluso stock

Interruttori a bilancere bipolari 6A 250V tasto con posizione 0 – 1 OMEGA

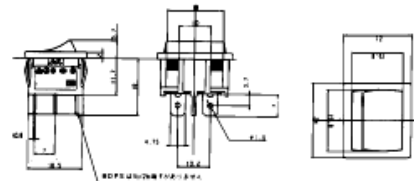

Corpo: makrolon nero
Contatti: in ottone stagnato
Per faston 6.3mm

Art.
6001-0435

Colore tasto
nero

Ordine minimo 100 pezzi escluso stock

Deviatori a bilancere bipolari 16A 250V con posizione 1 – 2 OMEGA

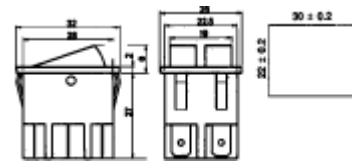

Corpo: nylon rinforzato vetro
Contatti: in ottone stagnato
Per faston 6.3mm

Art.
G-I4800

Colore tasto
nero

Ordine minimo 50 pezzi escluso stock

deviatori luminosi a bilancere bipolari 16A 250V con posizione 0 – 1 OMEGA

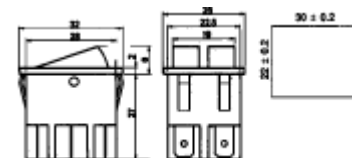

Corpo: nylon rinforzato vetro
Contatti: in ottone stagnato
Per faston 6.3mm

Art.
G-I4813
G-I4815

Colore tasto
rosso
verde

Ordine minimo 50 pezzi escluso stock

PULSANTI E INTERRUTTORI A BASCULA

interruttori a bilancere bipolari 16A 250V posizione 0 – 1 OMEGA

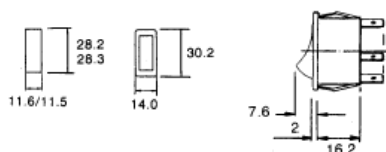

Corpo: nylon rinforzato vetro
Contatti: in ottone argentato

Art.
G-14800
G-14913
G-14915

Colore tasto
nero
Luminoso rosso
Luminoso verde

Ordine minimo 50 pezzi escluso stock

Pulsante a fungo 30mm IP65 OMRON



Corpo: termoplastico
UL508 – EN60947-5-1
125vac 5A - 250VAC 3A - 30VDC 3A

CODICE
6001-0370

Codice originale
A165E-S-02

Contatti
DPST-NC

Pulsante a fungo 40mm IP66 CEMA



Corpo: metallico
CENELEC EN 50007 – IEC529

CODICE
6001-0380

Codice originale
P9MER4RN

Contatti
rosso

Interruttori a bilancere bipolari 16A 250V tasto con posizione 0 – 1 OMEGA

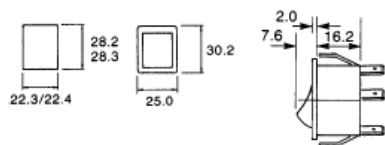

Corpo: nylon rinforzato vetro
Contatti: in ottone argentato

Art.
6001-0460

Colore tasto
Luminoso rosso

Ordine minimo 50 pezzi escluso stock

Pulsante luminoso IP66 CEMA



Corpo: termoplastico
CENELEC EN 50007 – IEC529

CODICE
6001-0385

Codice originale
P9XLRD

Contatti
rosso

deviatori a bilancere unipolari 3A 250V 1 – 2 OMEGA

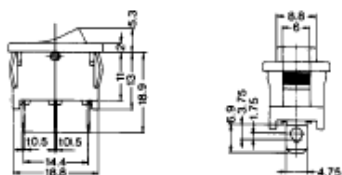

Corpo: nylon rinforzato vetro
Contatti: in ottone argentato

Art.
G-PRO2292

impiego

Contro spruzzi di acqua e polvere

Ordine minimo 100 pezzi escluso stock

Micropulsanti da circuito stampato

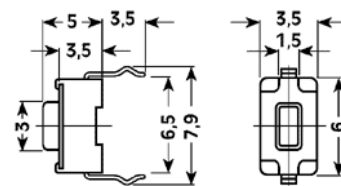

Corpo: nylon 66
Contatti: in ottone nichelato
Portata: 50mA 12V

Art.
G-TP110643
6002-0005

H
4.3
5.0

Forza di azionamento gr.
180
100

PULSANTI E INTERRUTTORI A BASCULA

Micropulsanti da circuito stampato nastrati in scatola da 1000 pezzi

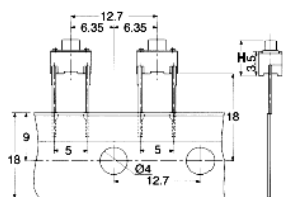
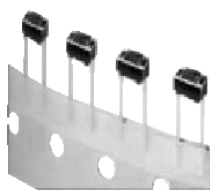

Corpo: nylon 66
Contatti: in ottone nichelato
Portata: 50mA 12V

Art.	H	Forza di azionamento gr.
G-DJ11011RT25043	4.3	250
G-DJ11011RT25043	5.0	250

Micropulsanti da circuito stampato 4x5.8mm

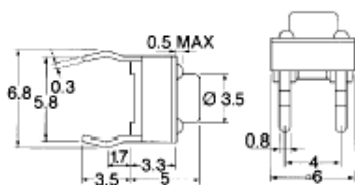

Corpo: nylon 66
Contatti: in ottone nichelato
Portata: 50mA 12V

Art.	H	Forza di azionamento gr.
G-DJ110816050	5.0	160

Ordine minimo 1000 pezzi escluso stock

Micropulsanti da circuito stampato 4.5x6.5mm

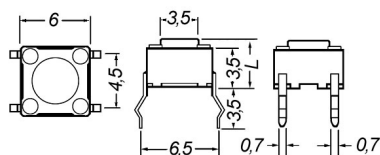

Corpo: nylon 66
Contatti: in ottone nichelato
Portata: 50mA 12V

Art.	H	Forza di azionamento gr.
6002-0010	4.3	160
G-TP1101A5	5.0	160
6002-0015	7.0	160
G-TP1101E73	7.3	160
G-TP1101C80	8.0	160
6002-0018	9.5	160
6002-0019	12.5	160
6002-0020	13.0	160
G-TP1101J17	17.0	160

Micropulsanti da circuito stampato 4.5x6.5mm

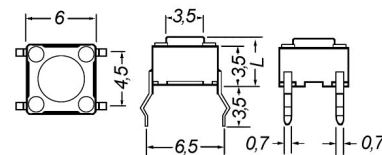

Corpo: nylon 66
Contatti: in ottone nichelato
Portata: 50mA 12V

Art.	H	Forza di azionamento gr.
G-DJ110225043	4.3	250
G-DJ110225050	5.0	250
G-DJ110225070	7.0	250
G-DJ110225073	7.3	250
G-DJ110225080	8.0	250
G-DJ110225095	9.5	250
G-DJ1102250130	13.0	250
G-DJ1102250135	13.5	250
6002-0023	17.0	250

Ordine minimo 1000 pezzi escluso stock

Micropulsanti da circuito stampato 4.5x6.5mm

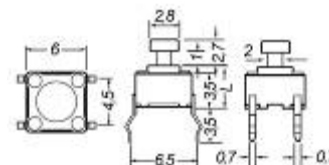

Corpo: nylon 66
Contatti: in ottone nichelato
Portata: 50mA 12V

Art.	H	L □	Forza di azionamento gr.
G-DJ1102T2416073	7.3	2.4	160
6002-0030	7.3	2.8	160

Ordine minimo 1000 pezzi escluso stock

Micropulsanti da circuito stampato Tipo verticale 4.5x7mm

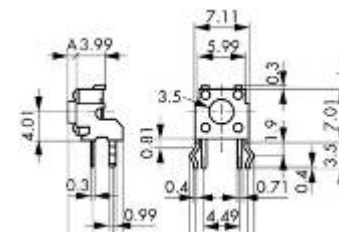

Corpo: nylon 66
Contatti: in ottone nichelato
Portata: 50mA 12V

Art.	H	Forza di azionamento gr.
6002-0050	3.85	160
G-DJ110225050	6.85	160
6002-0045	8.35	160
G-DJ110225073	11.85	160

Ordine minimo 1000 pezzi escluso stock

PULSANTI E INTERRUTTORI A BASCULA

Micropulsanti da circuito stampato Tipo verticale 4.5x7mm

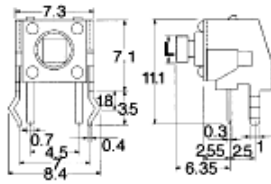

Corpo: nylon 66
Contatti: in ottone nichelato
Portata: 50mA 12V

Art.	H	L	Forza di azionamento
G-DJ1102NT160635	6.35	2.4	160 gr.

Ordine minimo 1000 pezzi escluso stock

Micropulsanti da circuito stampato

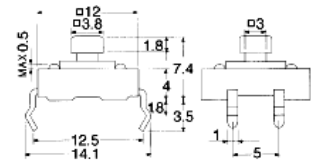

Corpo: nylon 66
Contatti: in ottone nichelato
Portata: 50mA 12V

Art.	H	Forza di azionamento gr.
G-DJ1103T16074BU66	7.3	160

Ordine minimo 1000 pezzi escluso stock

Micropulsanti da circuito stampato

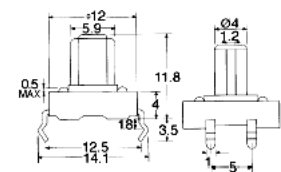

Corpo: nylon 66
Contatti: in ottone nichelato
Portata: 50mA 12V

Art.	H	Forza di azionamento gr.
G9219X	11.8	160

Micropulsanti da circuito stampato nastrati in scatola da 1000 pezzi

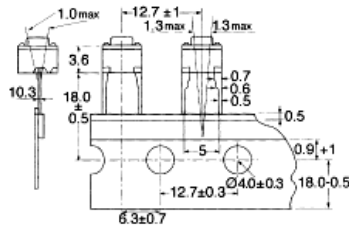
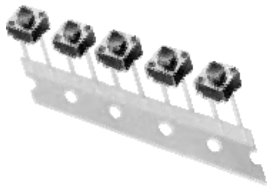

Corpo: nylon 66
Contatti: in ottone nichelato
Portata: 50mA 12V

Art.	H	Forza di azionamento gr.
G-DJ1104RT16043	4.3	160
G-DJ1104RT16050	5.0	160

Micropulsanti da circuito stampato

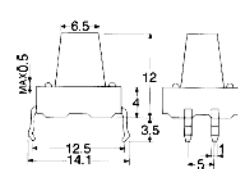

Corpo: nylon 66
Contatti: in ottone nichelato
Portata: 50mA 12V

Art.	H	Forza di azionamento gr.
6002-0019	12	160

Ordine minimo 1000 pezzi escluso stock

Micropulsanti da circuito stampato

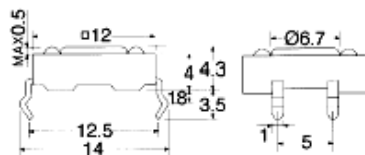

Corpo: nylon 66
Contatti: in ottone nichelato
Portata: 50mA 12V

Art.	H	Forza di azionamento gr.
6002-0055	4.3	160

PULSANTI E INTERRUTTORI A BASCULA

Micropulsanti per montaggio superficiale SMD

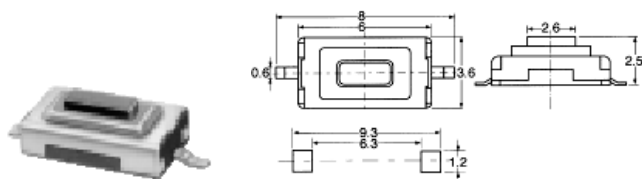

Corpo: nylon 46
Contatti: in ottone nichelato
Portata: 50mA 12V

Art.	H	Forza di azionamento gr.
G-DJ1107GS18025	2.5	160

Ordine minimo 3000 pezzi escluso stock

Micropulsanti per montaggio superficiale 4.5x9 SMD

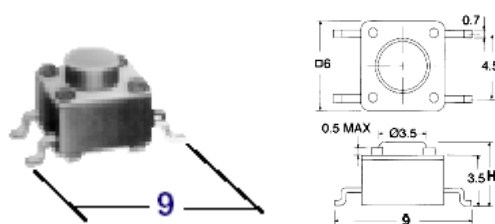

Corpo: nylon 66
Contatti: in ottone nichelato
Portata: 50mA 12V

Art.	H	Forza di azionamento gr.
G-DJ1102S250943	4.3	250
G-DJ1102SA250950	5.0	250
G-DJ1102SE250973	7.3	250
G-DJ1102SD250995	9.5	250

Ordine minimo 1000 pezzi escluso stock

Micropulsanti per montaggio superficiale SMD

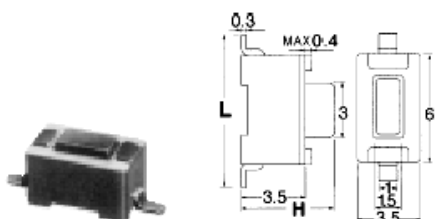

Corpo: nylon 46
Contatti: in ottone nichelato
Portata: 50mA 12V

Art.	H	Forza di azionamento gr.
G-DJ1101NE25043	4.3	250
G-DJ1101NEA25050	5.0	250

Ordine minimo 1200 pezzi escluso stock

Micropulsanti per montaggio superficiale 4.5x9 SMD

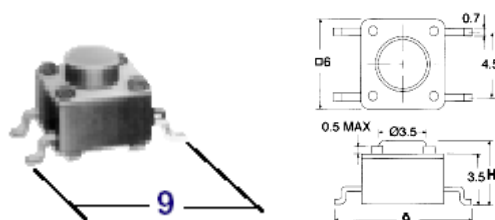

Corpo: nylon 46
Contatti: in ottone nichelato
Portata: 50mA 12V

Art.	H	Forza di azionamento gr.
G-DJ1102S160943	4.3	160
G-DJ1102SA160950	5.0	160

Ordine minimo 1000 pezzi escluso stock

Micropulsanti per montaggio superficiale 4.5x9 SMD

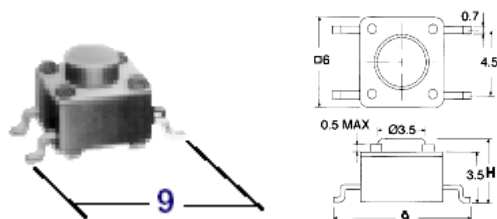

Corpo: nylon 66
Contatti: in ottone nichelato
Portata: 50mA 12V

Art.	H	Forza di azionamento gr.
G-DJ1102S160943	4.3	160
G-DJ1102SA160950	5.0	160
6002-0040	7.3	160
G-DJ1102SD160995	9.5	160

Ordine minimo 1000 pezzi escluso stock

Micropulsanti per montaggio superficiale 4.5x9 SMD

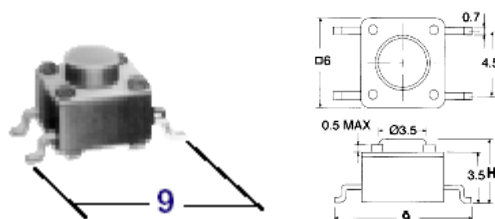

Corpo: nylon 46
Contatti: in ottone nichelato
Portata: 50mA 12V

Art.	H	Forza di azionamento gr.
G-DJ1102S250943	4.3	250
G-DJ1102SA250950	5.0	250

Ordine minimo 1000 pezzi escluso stock

PULSANTI E INTERRUTTORI A BASCULA

Micropulsanti per montaggio superficiale 4.5x10 SMD

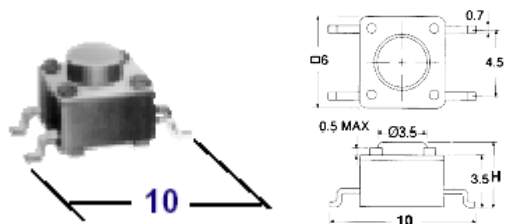

Corpo: nylon 46
Contatti: in ottone nichelato
Portata: 50mA 12V

Art.	H	Forza di azionamento gr.
6002-0025	4.3	160
G-DJ1102SA1601050	5.0	160

Ordine minimo 1000 pezzi escluso stock

Micropulsanti per montaggio superficiale SMD

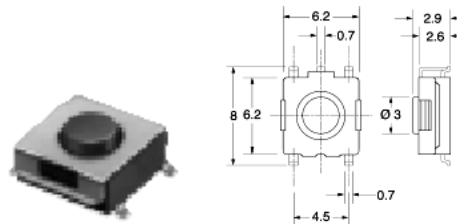

Corpo: nylon 66
Contatti: in ottone nichelato
Portata: 50mA 12V

Art.	H	Forza di azionamento gr.
G-TP1122B16029	2.9	160

Ordine minimo 1700 pezzi escluso stock

Micropulsanti per montaggio superficiale 4.5x10 SMD

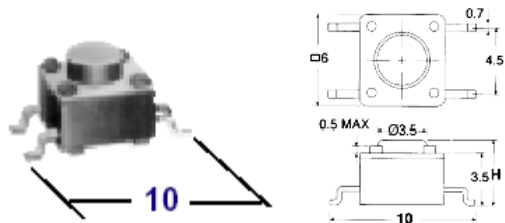

Corpo: nylon 46
Contatti: in ottone nichelato
Portata: 50mA 12V

Art.	H	Forza di azionamento gr.
G-DJ1102S2501043	4.3	250
G-DJ1102SA2501050	5.0	250
G-DJ1102SB2501070	7.0	250
G-DJ1102SE2501073	7.3	250
G-DJ1102SC1601080	8.0	160
G-DJ1102SD2501095	9.5	250

Ordine minimo 1000 pezzi escluso stock

Micropulsanti per montaggio superficiale Larghezza 9mm SMD

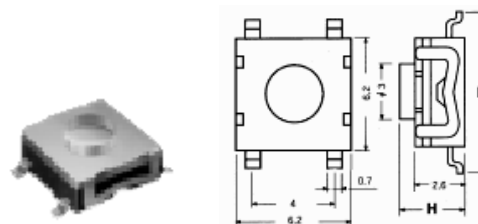

Corpo: nylon 66
Contatti: in ottone nichelato
Portata: 50mA 12V

Art.	H	Forza di azionamento gr.
G-TP1162C200951	5.1	200

Ordine minimo 1700 pezzi escluso stock

Micropulsanti per montaggio superficiale SMD

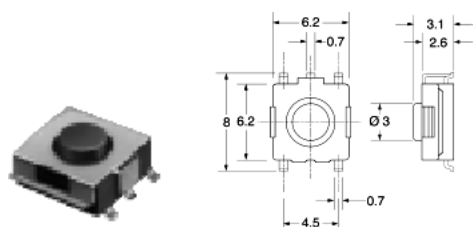

Corpo: nylon 66
Contatti: in ottone nichelato
Portata: 50mA 12V

Art.	H	Forza di azionamento gr.
G-TP112216031	3.1	160

Ordine minimo 1700 pezzi escluso stock

Micropulsanti per circuito stampato 4.5x6.5mm con led 160gr.

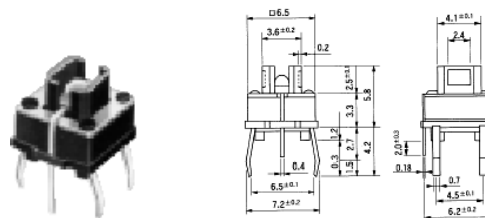

Corpo: nylon 66
Contatti: in ottone nichelato
Portata: 50mA 12V

Art.	Colore del led
G-TP1194R58	Rosso
G-TP1194G58	Verde
G-TP1194Y58	Giallo

Ordine minimo 1000 pezzi escluso stock

PULSANTI E INTERRUTTORI A BASCULA

Micropulsanti per circuito stampato 4.5x6.5mm con led 160gr.

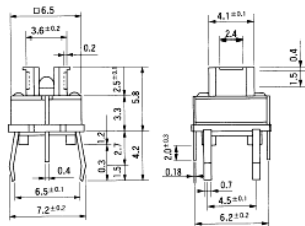

Corpo: nylon 66
Contatti: in ottone nichelato
Portata: 50mA 12V

Art.	Colore del led
G-TP1193R58	Rosso
G-TP1193G58	Verde
G-TP1193Y58	Giallo

Ordine minimo 1000 pezzi escluso stock

Micropulsanti da circuito stampato terminali a 90°

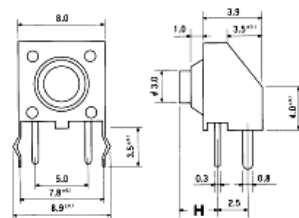

Corpo: nylon 66
Contatti: in ottone nichelato
Portata: 50mA 12V

Art.	H	Forza di azionamento gr.
G-TP1129435	4.35	200
G-TP1119A835	8.35	200
G-TP1119B1235	12.35	200

Ordine minimo 1000 pezzi escluso stock

Manopola per micropulsanti 1193 e 1194

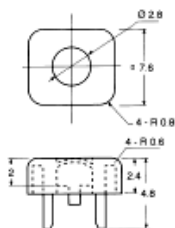
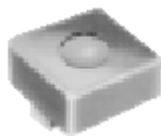

Corpo: nylon 66

Art.	Colore
G-TC1193W	Bianco
G-TC1193B	Nero

Ordine minimo 1000 pezzi escluso stock

pulsanti da circuito stampato 5.8x5.8x5 forza di attuazione 150+80gr.

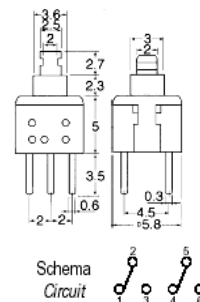

Dima di foratura
Hole layout

Schema
Circuit

Corpo: nylon 66
Portata: 0.1A, 30Vdc
Durata: 10000 cicli
Resistenza di isolamento: 500M

Art.	Tipo
G-DJ2216SL	Con ritenuta

Ordine minimo 1000 pezzi escluso stock

Micropulsanti da circuito stampato

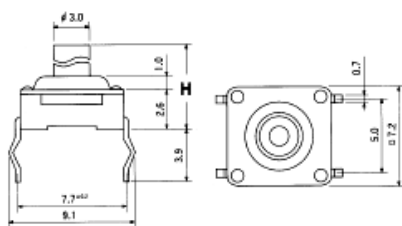

Corpo: nylon 66
Contatti: in ottone nichelato
Portata: 50mA 12V

Art.	H	Forza di azionamento gr.
6002-0030	5.0	200
G-TP1119A9	9.0	200
G-TP1119B13	13.0	200

Ordine minimo 1000 pezzi escluso stock

pulsanti da circuito stampato 7x7x7 forza di attuazione 200+80gr.

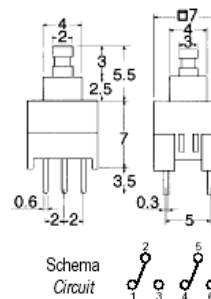

Dima di foratura
Hole layout

Schema
Circuit

Corpo: nylon 66
Portata: 0.1A, 30Vdc, durata: 10000 cicli
Resistenza di isolamento: 500M

Art.	Tipo
G-DJ2212SL	Con ritenuta
G-DJ2212NL	Momentaneo

Ordine minimo 1000 pezzi escluso stock

PULSANTI E INTERRUTTORI A BASCULA

pulsanti da circuito stampato 8x8x8
forza di attuazione 200+-80gr.

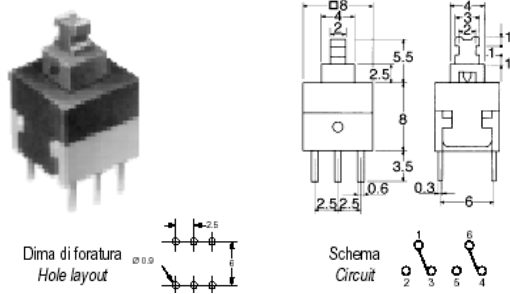

Corpo: nylon 66
Portata: 0.1A,30Vdc, durata: 10000 cicli
Resistenza di isolamento: 500M

Art. **G-DJ2215SL** Tipo Con ritenuta
G-DJ2215NL Tipo Momentaneo
Ordine minimo 1000 pezzi escluso stock

pulsanti da circuito stampato 11x11x7
forza di attuazione 200+-80gr.

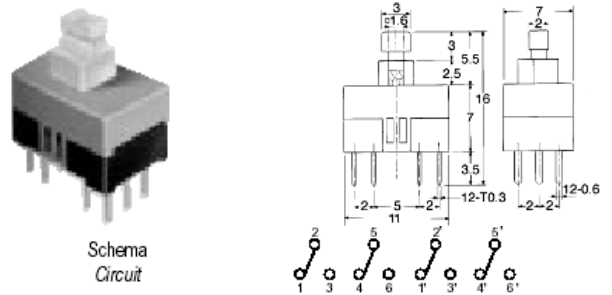

Corpo: nylon 66
Portata: 0.1A,30Vdc, durata: 10000 cicli
Resistenza di isolamento: 500M

Art. **G-DJ4201SL** Tipo Con ritenuta

pulsanti da circuito stampato 8.4x8.4x8.5
forza di attuazione 200+-80gr.

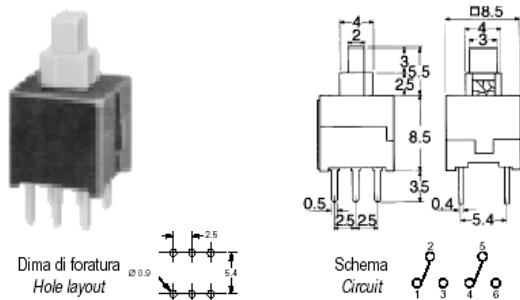

Corpo: nylon 66
Portata: 0.1A,30Vdc, durata: 10000 cicli
Resistenza di isolamento: 500M

Art. **G-DJ2214SL** Tipo Con ritenuta
G-DJ2214NL Tipo Momentaneo
Ordine minimo 1000 pezzi escluso stock

pulsanti da circuito stampato 13x8.5x8.5
forza di attuazione 300+-80gr.

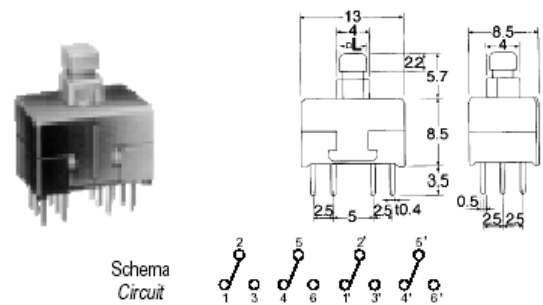

Corpo: nylon 66
Portata: 0.1A,30Vdc, durata: 10000 cicli
Resistenza di isolamento: 500M
L= 3.3

Art. **G-DJ4283SL** Tipo Con ritenuta

pulsanti da circuito stampato 10x9.5x8.5
forza di attuazione 200+-80gr.

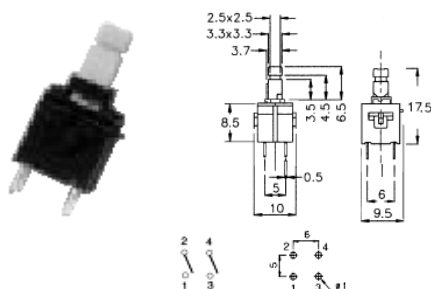

Corpo: nylon 66
Portata: 0.1A,30Vdc, durata: 10000 cicli
Resistenza di isolamento: 500M

Art. **G-CSSNT652P** Tipo momentaneo

pulsanti da circuito stampato con ritenuta
forza di attuazione 240+-50gr.

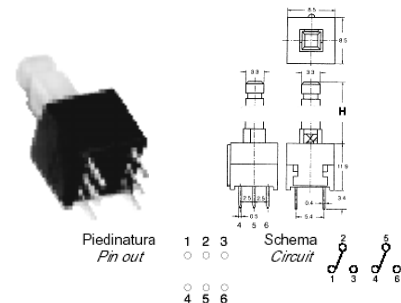

Corpo: nylon 66
Portata: 0.1A,30Vdc, durata: 50000 cicli
Resistenza di isolamento: 100M

Art. **G-LTV85S90** H 9.0
G-LTV85S95 H 9.5

PULSANTI E INTERRUTTORI A BASCULA

**pulsanti da circuito stampato momentanei
forza di attuazione 240+-50gr.**

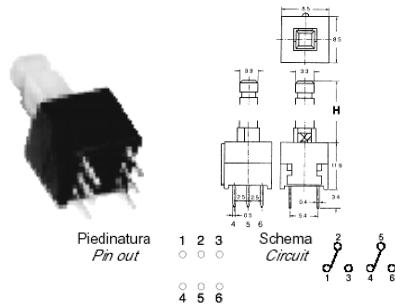

Corpo: nylon 66
Portata: 0.1A,30Vdc, durata: 50000 cicli
Resistenza di isolamento: 100M

Art. **G-LTV85N90** H 9.0
G-LTV85N95 H 9.5
G-LTV85N1125 H 11.25

**pulsanti da circuito stampato con ritenuta
forza di attuazione 240+-50gr. H = 9.5mm**

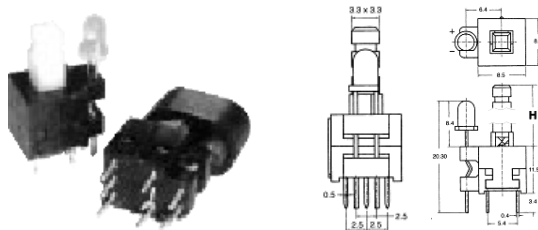

Corpo: nylon 66
Portata: 0.1A,30Vdc, durata: 50000 cicli
Resistenza di isolamento: 100M
Con led 3mm

Art. **G-LTV85SR95** Colore del led Rosso
G-LTV85SG95 Colore del led Verde

**pulsanti da circuito stampato momentanei
forza di attuazione 240+-50gr. H = 11.25mm**

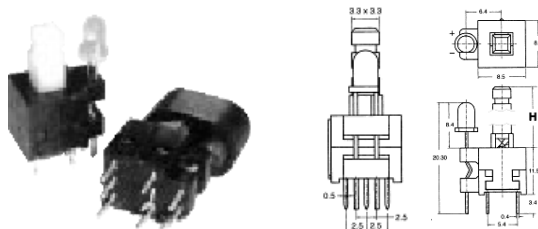

Corpo: nylon 66
Portata: 0.1A,30Vdc, durata: 50000 cicli
Resistenza di isolamento: 100M
Con led 3mm

Art. **G-LTV85NR1125** Colore del led Rosso

Copritasto con finestra

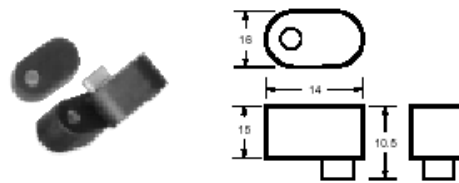

Corpo: nylon 66

Art. **G-PL3**

Copritasto senza finestra

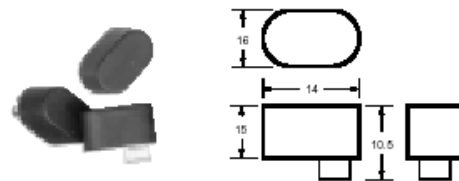

Corpo: nylon 66

Art. **G-PL4**

**pulsanti da circuito stampato momentanei
forza di azionamento 130gr.+30%**

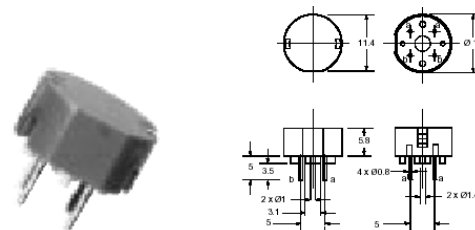

Corpo: nylon 66
Portata: 10mA,35Vdc, durata: 500.000 cicli
Resistenza di isolamento: 100.000M

Art. **G-KSLGR** Colore grigio
Ordine minimo 500 pezzi escluso stock

**pulsanti da circuito stampato momentanei
forza di azionamento 130gr.+30%**

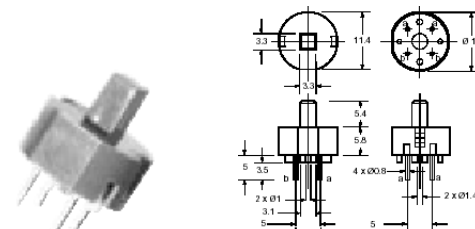

Corpo: nylon 66
Portata: 10mA,35Vdc, durata: 500.000 cicli
Resistenza di isolamento: 100.000M

Art. **G-KSPNE** Colore Nero
Ordine minimo 500 pezzi escluso stock

PULSANTI E INTERRUTTORI A BASCULA

**pulsanti da circuito stampato momentanei
forza di azionamento 130gr.+30%**

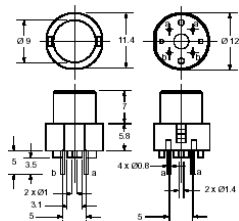

Corpo: nylon 66
Portata: 10mA,35Vdc, durata: 500.000 cicli
Resistenza di isolamento: 100.000M

Art.
GPUL/D6R/00
G-KSRNE
G-KSRRO
G-KSRGR
G-KSRBL
G-KSRVE
G-KSRGI

Colore
Bianco
Nero
Rosso
Grigio
Blu
Verde
Giallo

Ordine minimo 500 pezzi escluso stock

**pulsanti da circuito stampato momentanei
forza di azionamento 130gr.+30%**

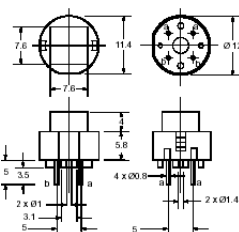

Corpo: nylon 66
Portata: 10mA,35Vdc, durata: 500.000 cicli
Resistenza di isolamento: 100.000M

Art.
G-KSSBI
G-KSSNE
G-KSSRO
G-KSSGR
G-KSSBL
G-KSSGI

Colore
Bianco
Nero
Rosso
Grigio
Blu
Giallo

Ordine minimo 500 pezzi escluso stock

pulsanti da circuito stampato



Corpo: termoplastico
Contatti: ottone nichelato
Portata: 25mA- 60V

Art.
G9197
GP/500RO
G9193
G9196

Colore
Rosso chiaro
Rosso scuro
Arancio
verde

Tasto per pulsanti

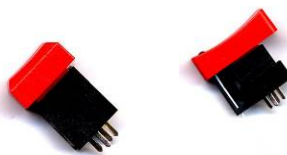

Corpo: termoplastico

Quadrato

Art.
G9206
G9209
G9211
G9208

Colore
Rosso
Giallo
Verde scuro
grigio

Rettangolare con foro x led 3mm

Art.
G9221
G9223
G9224
G9222

Colore
Rosso
Giallo
Verde scuro
grigio

Ghiera porta led



Corpo: termoplastico

Art.
G9201

Colore
nero

**pulsanti da circuito stampato 10x10
tasto quadrato**



Corpo: termoplastico
Contatti: ottone nichelato
Portata: 25mA- 60V

Art.
G9186
G9191
G9192
G9188
G9187

Colore
Rosso
Verde
Grigio
Blu
Nero

**Interruttore momentaneo con foro per led
da 3mm**



Corpo: termoplastico
Contatti: ottone nichelato
Portata: 100mA

Art.
G9229

Colore
nero

PULSANTI E INTERRUTTORI A BASCULA

pulsanti da circuito stampato 12.4x12.4x7.5



Corpo: termoplastico
Contatti: ottone nichelato
Portata: 25mA– 60V

Art.	Colore
G-P56R	Rosso
G9186	Nero
G-P56G	Giallo
G-P56V	Verde
G-P56BI	Bianco

Base pulsante da circuito stampato MDP CANNON

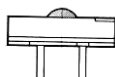

Corpo: termoplastico
Contatti: ottone nichelato
Portata: 25mA– 60V

Art.
G9218

Tasti per pulsante da circuito stampato MDP CANNON



Corpo: termoplastico

Art.	Colore
G9225	rosso
G9226	Verde
G9227	Blu

Pulsante per circuito stampato 15x14.2x9.7 RAFI RF15



Corpo: termoplastico
Contatti: ottone nichelato
Portata: 100mA

Art.	articolo
GP/31410006	Non luminoso
GP/314100041	Luminoso 1 led rosso